

CHEESNEY'S

ALCHEMY GAS FIRE COLLECTION





CHESNEY'S

Contents

Introduction	2
The Alchemy Glass Fronted Gas Fire Range	4
GFP 500	6
GFP 700	10
GFL 700	14
GFL 850	16
GF Technical Information	18
The Alchemy DFE Gas Fire Range	22
DFE Coal Fire	24
DFE Log Fire	26
Fire Baskets and Andirons	28
DFE Technical Information	37

The Alchemy Range of Gas Fires

At the heart of every fireplace is the fire itself, but in today's busy world many people simply don't have the time to build and tend a real fire. A Chesney's Alchemy gas coal or log effect fire can provide the answer, offering immediate enjoyment of the beauty and warmth of a real fire at the flick of a switch.



Efficiency

In an era of soaring energy prices Chesney's is committed to developing products that deliver the highest levels of efficiency with the minimum running costs.

Our open fronted gas effect fires are an attractive and realistic recreation of a real fire rather than a primary heat source but our glass fronted fires deliver outstanding performance, achieving levels of up to 80% efficiency in independent testing. This allows an expensive energy source to be harnessed and utilised in a highly economical manner.

Functionality

Chesney's is engaged in a year round research and development programme at our in-house facility in Yorkshire. Our engineers work with our designers to combine the latest technology with a design aesthetic that results in products that are unique in their marriage of functionality and appearance.

Whilst high tech features such as thermostatic room temperature control and remote adjustment of flame height and heat output are available, no compromise is made in relation to the beautiful appearance of the fire.

Realism

Our aim is to create a range of fires that look as much as possible like the real thing.

Following endless experiments we have created flame patterns that are both generous and realistic, emulating the flame patterns of a real fire with individually hand painted logs that produce a deep life-like glow.

Whether in a traditional fire basket or behind glass, an Alchemy fire is almost indistinguishable from a natural fire.

Safety

With any gas appliance, safety is of paramount importance.

The Alchemy range has been tested and certified by the UK's leading independent test laboratory and our rigorous quality control systems ensure that all our appliances conform to British Safety Standards.

GFP 700 with block limestone effect interior panels, Faulkner fire dogs, Swansnest fire basket and Faulkner fireplace in limestone.

Installed with a recessed fire chamber floor.



Alchemy Glass Fronted Gas Fire Range

Placing a gas effect fire behind glass and within a sealed steel chamber exponentially increases its efficiency but can detract significantly from the appearance of the fire.

Uniquely, the Chesney's collection of glass fronted gas fires, the Alchemy GF range, succeeds in delivering outstanding levels of efficiency with no compromise in its ambitious and innovative design aesthetic. These fires not only look wonderful but they also work as highly effective and sophisticated convector heating appliances, achieving efficiency ratings of up to 80%.

Manufactured in the UK by a highly skilled work force using state of the art technology, the Alchemy GF range embodies precision engineering and intelligent design. Only the best materials and components are used with both inner chamber and outer casing fabricated from heavy gauge heat resistant steel to ensure optimum heat emissions and a long life for the appliance. Chesney's confidence in the reliability and performance of the product is reflected in the 5 year guarantee[†] that is given for all non-consumable parts.

Outstanding engineering and performance are only half the story. Every Chesney's product also has to satisfy the most challenging aesthetic design criteria. It must be innovative, original and beautiful. The Alchemy GF range meets these criteria. Every model in the range uses premium non-reflective "invisible" glass. This feature underpins the unique appeal of the range appearing to bring the fire right into the room.

The traditional range offers fire baskets and fire dogs as an option and a range of stone effect interior panels including block limestone, plain limestone and rustic Cotswold stone.

The contemporary range includes a polished bronze fire urn and mirror finish black glass panels amongst its unique features.



Detail from GFP 700 with rustic stone effect interior panels.

[†]The appliance is required to be annually serviced in order to maintain the 5 year manufacturer's warranty.



The Alchemy GFP 500

With its portrait sized proportions the Alchemy GFP 500 is ideally suited as the interior to a fire surround.

It is shown here with contemporary limestone effect panels and log fire inside the Devonshire limestone surround with matching hearth and slips. All models in the Alchemy GF range are available with a choice of interior panels.









The Alchemy GFP 500

The Alchemy GFP 500 is shown here inside the Classic Victorian limestone surround with a black slate hearth and slips and black interior panels accentuating the generous flame patterns.



Alchemy GFP 500

The Alchemy GFP 700

The Alchemy GFP 700 is shown with contemporary block limestone effect panels, brushed nickel plated Spherical fire dogs and Swansnest fire basket. It is framed by limestone slips and sits within the limestone Burlington surround on a matching limestone hearth.



The Alchemy GFP 700

The Limoges, a large French stone chimneypiece, combines perfectly with the Alchemy GFP 700, shown here with rustic stone effect panels and log fire.



Alchemy GFP 700





The Alchemy GFL 700

With its landscape proportions the Alchemy GFL 700 is a mesmerising addition to a room where a traditional fire surround is not required.

The GFL range comes with a choice of decorative frames which are manufactured in one piece giving a smooth quality finish. Shown here with a standard black frame and black reeded interior panels.





The Alchemy GFL 850

The large Alchemy GFL 850 is shown with a black frame, bronze Olympic Fire Urn* and reflective black glass interior panels.



Alchemy GFL 850

Alchemy GF Range Frame & Interior Panel Guide

Our range of frame and interior panel options allows you the flexibility to select a colour and finish that will suit the decorative scheme in your home.

Frames

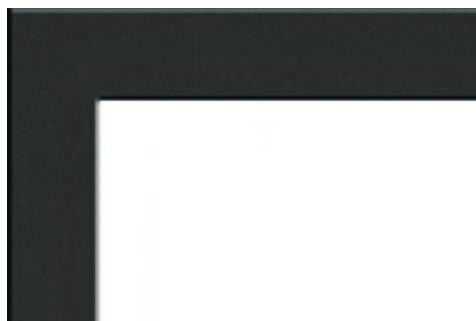

Black 40 mm (standard)



Black 80 mm



Black 100 mm x 75 mm

FRAME COMPATIBILITY CHART

MODEL	BLACK 40	BLACK 80	BLACK 100/75
GFP 500	S	✓	X
GFP 700 / 700H	S	✓	X
GFL 700	S	✓	✓
GFL 850	S	✓	X
GFL 850 URN	S	✓	X

COMPATIBILITY CHART KEY:

S = STANDARD

✓ = OPTION AVAILABLE

X = OPTION NOT AVAILABLE

Interior Panels

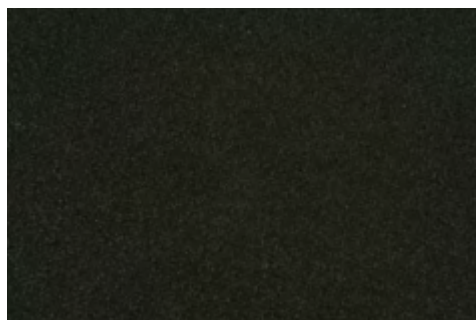

Plain Black (standard)



Reeded Black

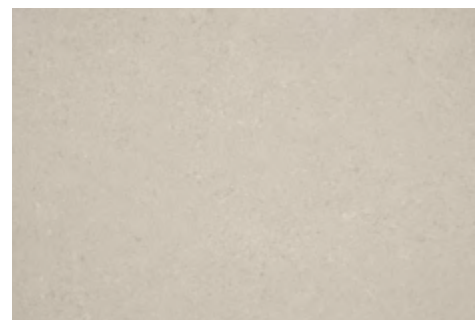

Contemporary Plain Limestone

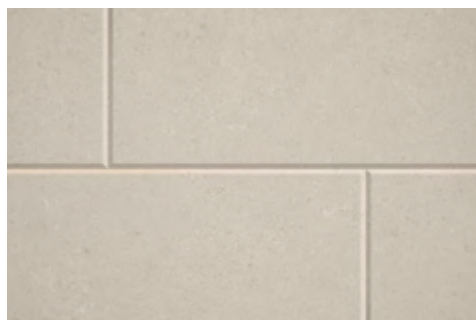

Contemporary Block Limestone

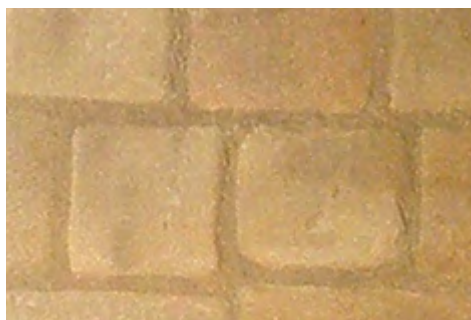

Rustic Stone

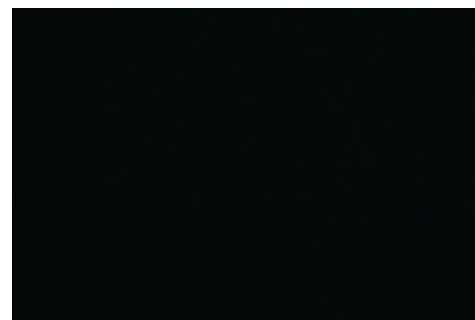

Reflective Black Glass

INTERIOR PANEL COMPATIBILITY CHART

MODEL	PLAIN BLACK	REEDED BLACK	CONTEMPORARY PLAIN LIMESTONE	CONTEMPORARY BLOCK LIMESTONE	RUSTIC STONE	REFLECTIVE BLACK GLASS
GFP 500	S	✓	✓	X	X	X
GFP 700 / 700H	S	✓	X	✓	✓	X
GFL 700	S	✓	✓	X	X	X
GFL 850	S	✓	✓	X	X	X
GFL 850 URN	S	✓	✓	X	X	✓

BASKETS, FIRE DOGS & LOGS COMPATIBILITY CHART

MODEL	SWANSNEST BASKET	SPHERICAL DOGS	FAULKNER DOGS	WIGWAM LOGS	FLAT LOGS	BRONZE URN
GFP 500	X	X	X	S	X	X
GFP 700 / 700H	✓	✓	✓	S	X	X
GFL 700	X	X	X	X	S	X
GFL 850	X	X	X	X	S	X
GFL 850 URN	X	X	X	X	X	S

Technical Data

GAS TYPE	GAS CATEGORY, TYPE AND SUPPLY PRESSURE	COUNTRY OF DESTINATION																										
		AT	BG	CH	CY	CZ	DE	DK	EE	ES	FI	FR	GB	GR	HR	IE	IT	LT	LU	LV	NO	PL	PT	RO	SE	SI	SK	TR
NG	I _{2H} - G20 at 20mbar	✓	✓	✓		✓		✓	✓	✓	✓		✓	✓	✓	✓	✓	✓		✓	✓		✓	✓	✓	✓	✓	✓

MODEL	NOMINAL HEAT INPUT	GAS INPUT ON REDUCED SETTING	NET EFFICIENCY %	EFFICIENCY CLASS
GFP 500	6.6kW	3.4kW	79.5	2
GFP 700	6.6kW	4.7kW	80.7	2
GFP 700H	9.1kW	4.5kW	83.6	1
GFL 700	6.0kW	4.3kW	78.3	2
GFL 850	6.5kW	4.5kW	74.7	2
GFL 850 URN	5.8kW		74.7	2

Builders Opening Requirements

Use non-combustible heat resistant materials for the chimney breast, including the top of the chimney breast, the material in the chimney breast and the back wall of the chimney breast. The construction must comply with all relevant regulations.

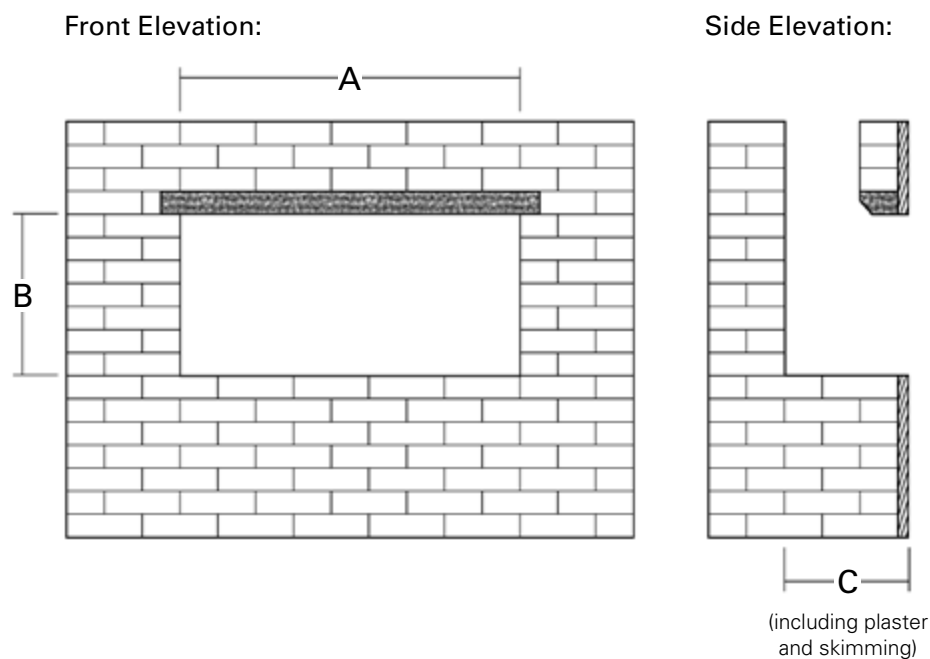

MODEL	A	B	C
GFP 500	560mm	695mm	355mm
GFP 700 / 700H	760mm	895mm	355mm
GFL 700	760mm	520mm	355mm
GFL 850 / 850 URN	910mm	520mm	355mm

Chesney's recommends lining the chimney to ensure correct operation. Flue runs should not be fitted to a chimney with a length in excess of 12m internal or 10m external to the building. Do not install the appliance in a bathroom or a room that contains a bath or shower.

Technical Drawings

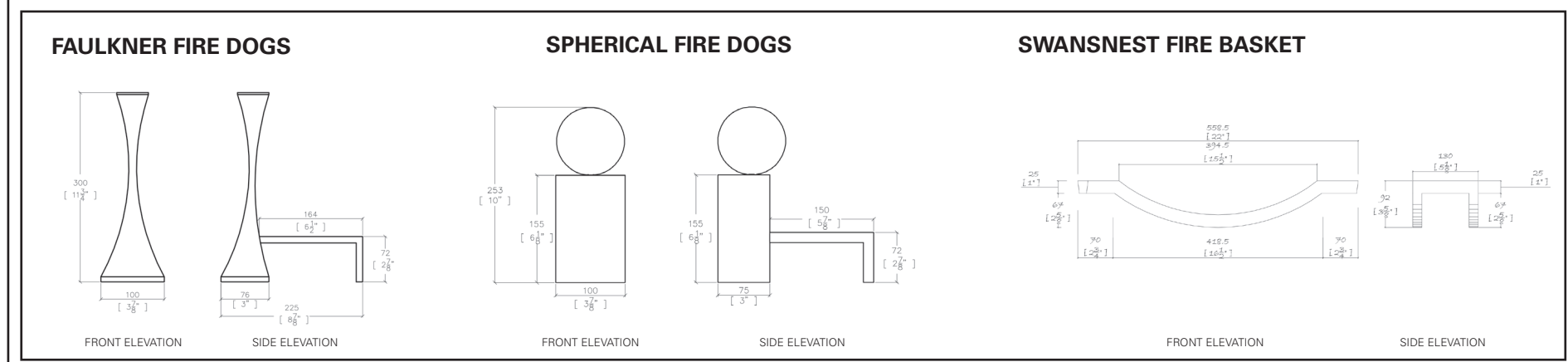
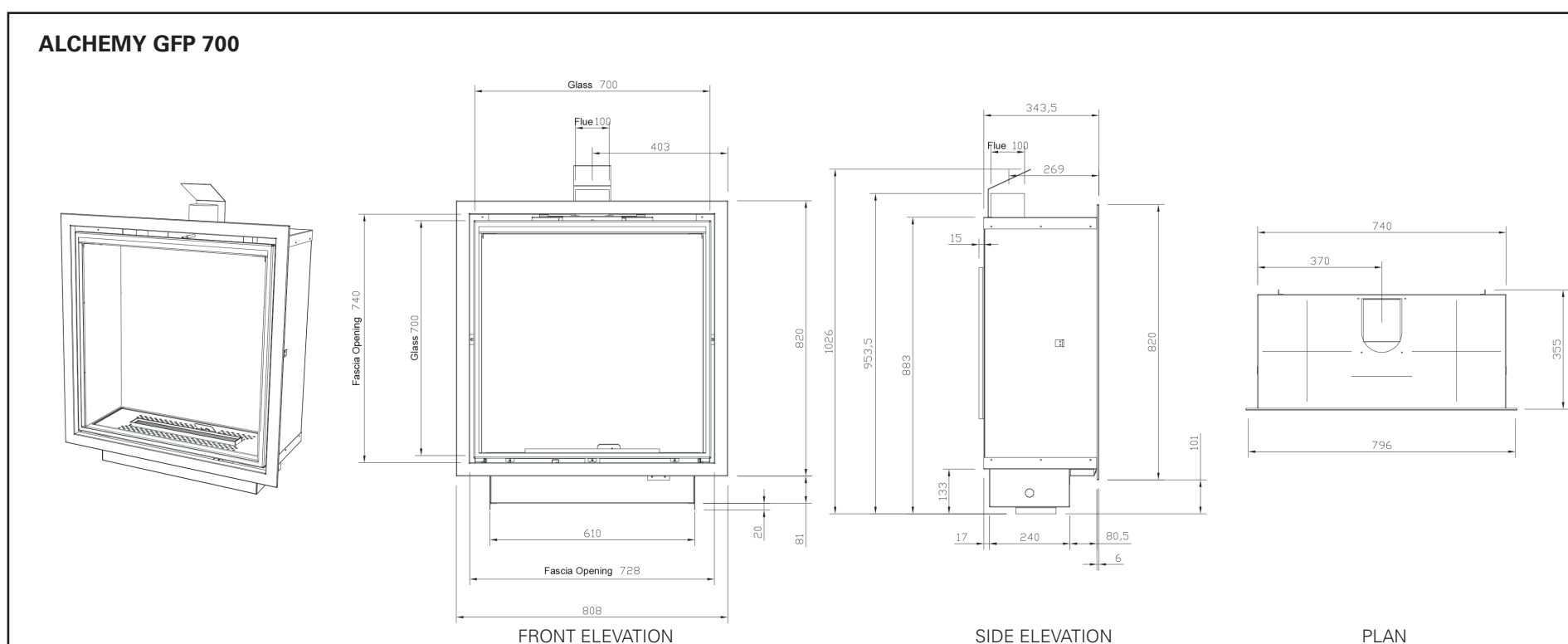
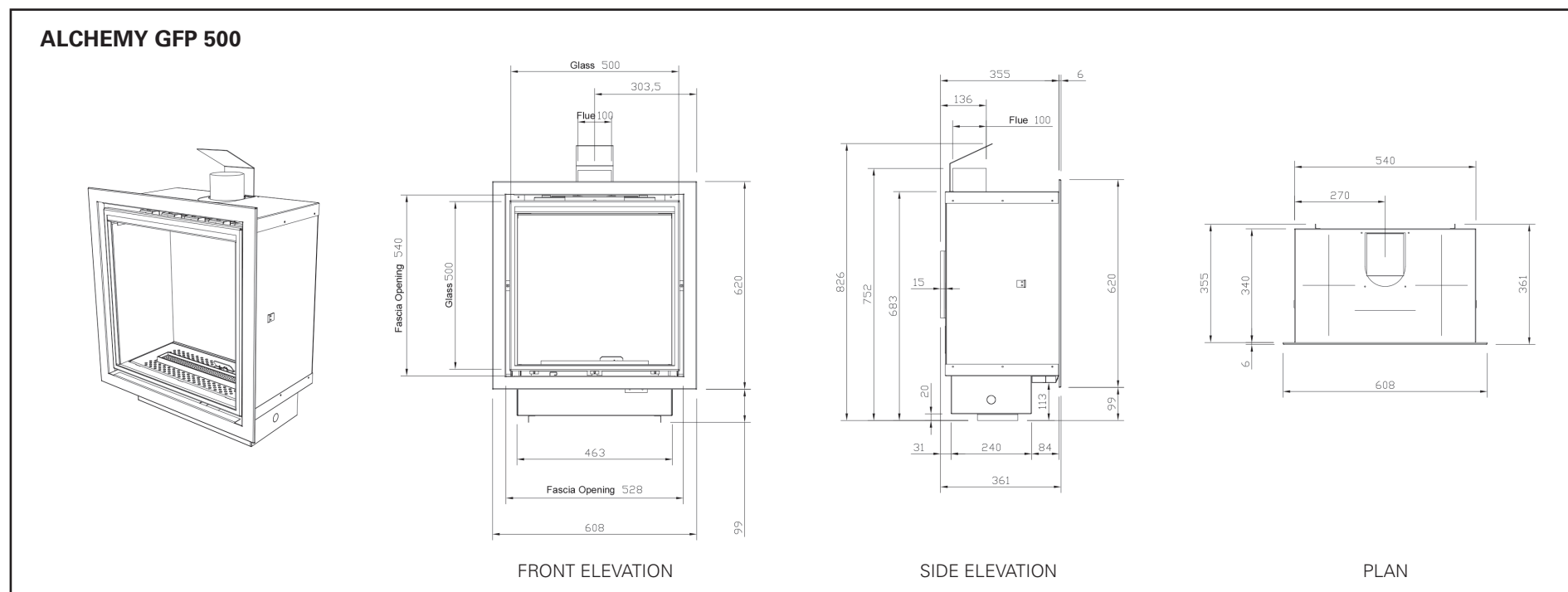

ALCHEMY GFL 700

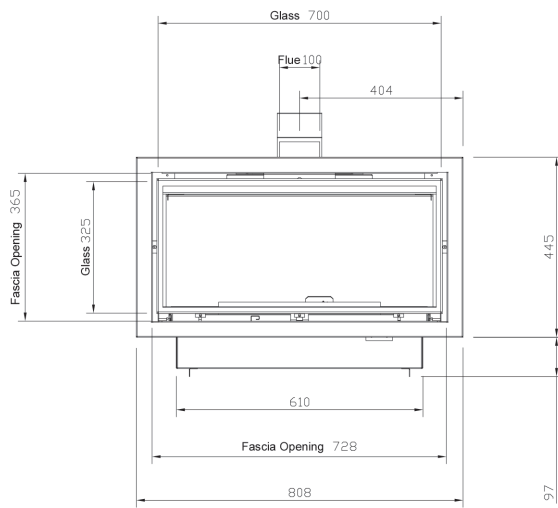
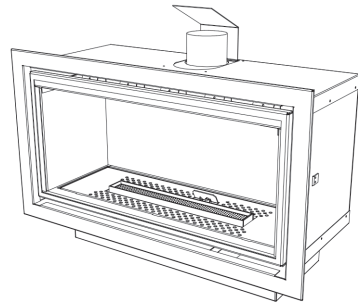

FRONT ELEVATION

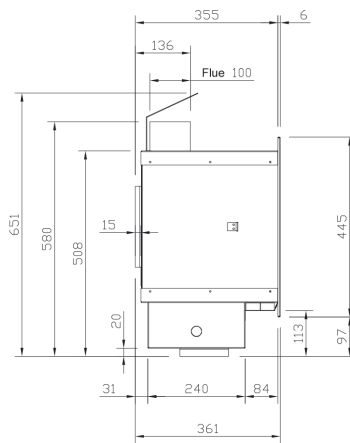

SIDE ELEVATION

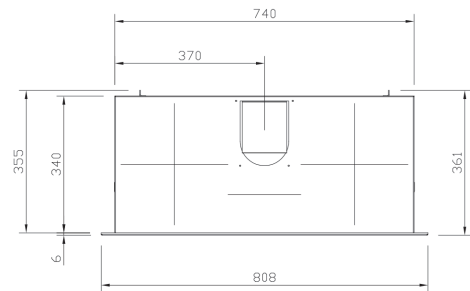

PLAN

ALCHEMY GFL 850

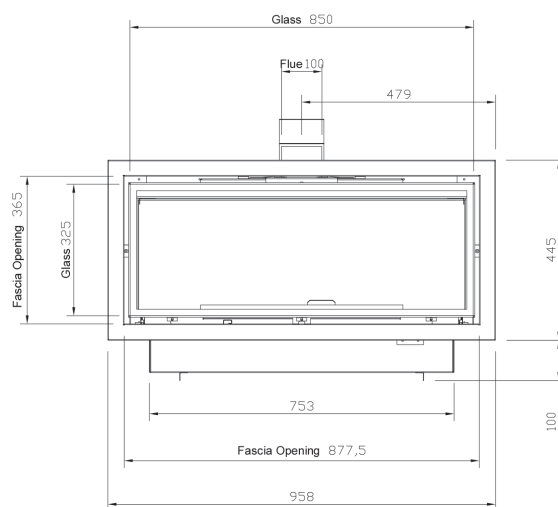
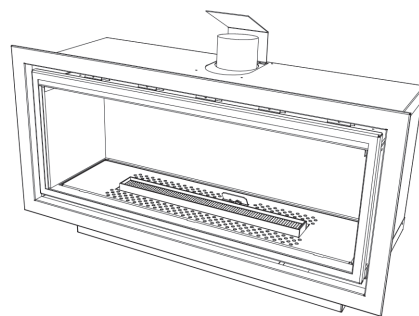

FRONT ELEVATION

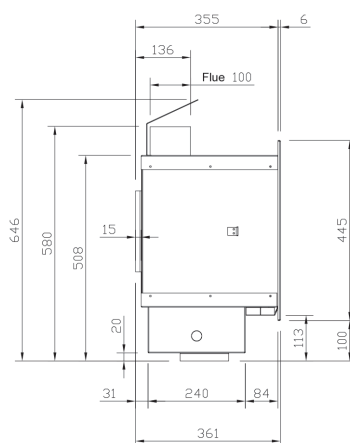

SIDE ELEVATION

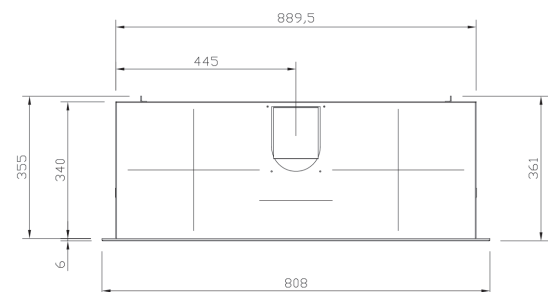

PLAN

Alchemy DFE Gas Fire Range

Chesney's offer an extensive range of fire baskets, fire dogs and register grates. Whilst these can all be used for burning solid fuel, they are equally attractive when combined with a gas coal or log effect fire from Chesney's Alchemy DFE range of gas fires.

An Alchemy DFE gas fire is a robust piece of engineering with every fire undergoing a rigorous build and testing process. These fires incorporate both a flame failure device and an oxygen depletion sensor and can either be operated manually or with a remote control function. It is our aim to create a fire that looks as life-like as possible and the combination of realistic flame patterns, individually hand painted logs and deep glow mean that every Alchemy fire is uniquely captivating.

The majority of fire baskets and register grates in the Chesney's range have an Alchemy DFE coal or log fire to suit.





The Alchemy DFE Coal Fire

Chesney's has a unique collection of fire baskets and dogs which can all be used with its Alchemy DFE range of gas fires.

This collection ranges from the stunning modernity of contemporary polished steel fire dogs and baskets to the hand engraved beauty of 18th century neo-classical fire baskets and an artisan crafted range of forged steel baskets and andirons.

The Alchemy DFE coal fire is shown with the Soho fire basket, Spherical fire dogs, Modern steel slips and limestone Burlington fire surround.

The Alchemy DFE Log Fire

Each log in a Chesney's Alchemy DFE log fire is individually hand painted. This attention to detail results in a fire of extraordinarily realistic and attractive appearance.

The Alchemy DFE log fire is shown with the Morris fire basket and Burton andirons inside the Limoges fire surround.





1 SYON in steel
Width 27 $\frac{1}{2}$ " (699)
Depth 13" (331)
Height 27 $\frac{1}{8}$ " (690)

2 CADOGAN in steel
(also available in brass)
Width 21 $\frac{3}{8}$ " (543)
Depth 12 $\frac{1}{8}$ " (310)
Height 21 $\frac{5}{8}$ " (548)

3 CROOME in brass
Width 33 $\frac{1}{2}$ " (850)
Depth 15" (380)
Height 33 $\frac{5}{8}$ " (855)

4 DORCHESTER in brass
(also available in steel)
Width 29" (735)
Depth 15" (382)
Height 25 $\frac{1}{4}$ " (640)

1

2

4

3

Dimensions given are for overall width, depth and height.



5 STANHOPE in brass
(also available in steel)
Width 21¹/₂" (545)
Depth 12" (305)
Height 21⁵/₈" (548)

7 SYON in brass
Width 27¹/₂" (699)
Depth 13" (331)
Height 27¹/₈" (690)

8 CROOME in steel
Width 33¹/₂" (850)
Depth 15" (380)
Height 33⁵/₈" (855)

6 OSTERLEY in brass
(also available in steel)
Width 26⁵/₈" (678)
Depth 14⁵/₈" (371)
Height 27¹/₈" (690)



5



6



7



8

1 OSBORNE

S Width 18" (457)
 S Depth 13" (331)
 S Height 10" (255)

M Width 22" (558)
 M Depth 13" (331)
 M Height 10" (255)

2 POPULAR

S Width 18" (457)
 S Depth 12 1/2" (317)
 S Height 13 1/4" (336)

M Width 22" (558)
 M Depth 12 1/2" (317)
 M Height 13 1/4" (336)

3 DUCKSNEST WITH BALLHEAD DOGS

S Width 18" (457)
 S Depth 13" (331)
 S Height 5 3/4" (145)

M Width 22" (558)
 M Depth 13" (331)
 M Height 5 3/4" (145)

Additional 3 3/4" (95) to overall width for arms

4 SOHO

S Width 17 5/8" (447)
 S Depth 12" (305)
 S Height 9 3/8" (238)

M Width 21 5/8" (548)
 M Depth 12" (305)
 M Height 9 3/8" (238)

Available in other sizes to order



1



2



3



4

Dimensions given are for overall width, depth and height. All baskets featured are in steel.

S Small basket
 M Medium basket

5 FIBONACCI

S Width 18" (457)
 S Depth 12⁵/₈" (321)
 S Height 9¹/₂" (240)

M Width 22" (558)
 M Depth 12⁵/₈" (321)
 M Height 9¹/₂" (240)

6 AMHURST

S Width 18" (457)
 S Depth 12¹/₄" (312)
 S Height 12¹/₂" (317)

M Width 22" (558)
 M Depth 12¹/₄" (312)
 M Height 12¹/₂" (317)

7 SOHO WITH SPHERICAL DOGS

S Width 18" (457)
 S Depth 12" (305)
 S Height 5¹/₂" (140)

M Width 22" (558)
 M Depth 12" (305)
 M Height 5¹/₂" (140)

8 FREESTANDING DUCKSNEST

S Width 18" (457)
 S Depth 13" (331)
 S Height 9⁵/₈" (242)

M Width 22" (558)
 M Depth 13" (331)
 M Height 9⁵/₈" (242)

Additional 6¹/₄" (158) to overall width for arms

Available in other sizes to order



5

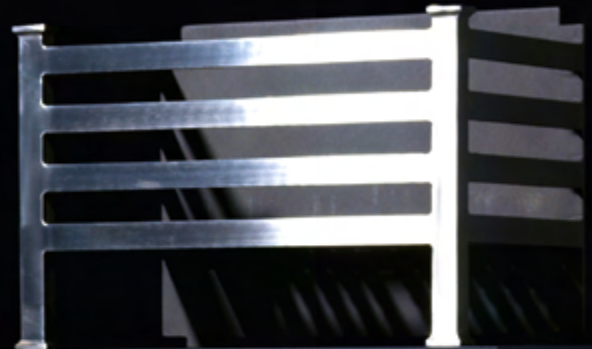

6



7

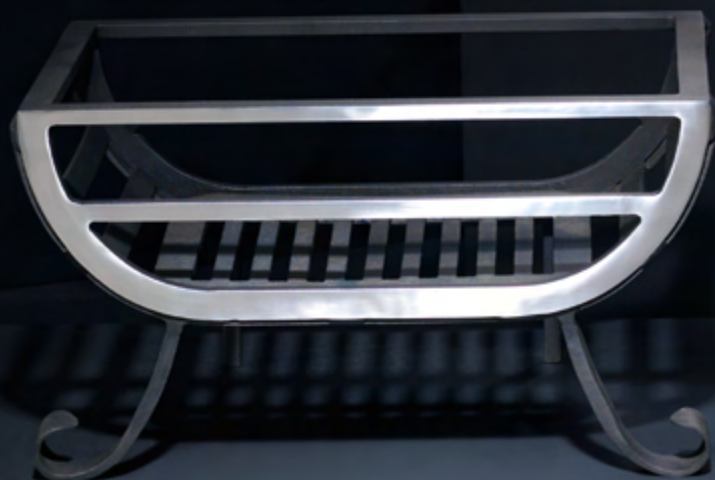

8

1 MODI

Width 3⁷/₈" (98)
Depth 19⁷/₈" (505)
Height 14" (356)

3 SPHERICAL

Width 3⁷/₈" (98)
Depth 18" (457)
Height 10" (254)

2 TOTEM

Width 4" (102)
Depth 17⁷/₈" (455)
Height 12" (305)

4 OBELISK

Width 3³/₈" (86)
Depth 17¹/₂" (444)
Height 12¹/₄" (311)



Dimensions given are for overall width, depth and height. All fire dogs featured are in steel.

5 BALLHEAD

Width 9" (230)
 Depth 16⁵/₈" (423)
 Height 16³/₈" (415)

6 MERIDIAN

Width 5¹/₂" (140)
 Depth 18" (457)
 Height 12" (305)

7 FAULKNER

Width 3⁷/₈" (98)
 Depth 18⁷/₈" (460)
 Height 13³/₄" (350)



1 TYNDALE
FREESTANDING

S Width 18" (457)
S Depth 12" (305)
S Height 12½" (317)

L Width 22" (558)
L Depth 12" (305)
L Height 12½" (317)

2 BAIRD
FREESTANDING

S Width 18" (457)
S Depth 12" (305)
S Height 9½" (242)

L Width 22" (558)
L Depth 12" (305)
L Height 9½" (242)

3 MORRIS FIRE BASKET
FOR DOGS

S Width 18" (457)
S Depth 12" (305)
S Height 5½" (140)

L Width 22" (558)
L Depth 12" (305)
L Height 5½" (140)

BURTON ANDIRONS

Width 9½" (242)
Depth 20¼" (514)
Height 17⅛" (436)



All baskets are available as freestanding or used in conjunction with fire dogs/andirons.

4 MORRIS
FREESTANDING

S Width 18" (457)
S Depth 12" (305)
S Height 9 1/2" (242)

L Width 22" (558)
L Depth 12" (305)
L Height 9 1/2" (242)

5 BYRON
FREESTANDING

S Width 18" (457)
S Depth 12 5/8" (321)
S Height 9 1/2" (242)

L Width 22" (558)
L Depth 12 5/8" (321)
L Height 9 1/2" (242)

6 CAXTON
FREESTANDING

S Width 18" (457)
S Depth 12" (305)
S Height 9 1/2" (242)

L Width 22" (558)
L Depth 12" (305)
L Height 9 1/2" (242)

7 BYRON FIRE BASKET
FOR DOGS

S Width 18" (457)
S Depth 12" (305)
S Height 5 1/2" (140)

L Width 22" (558)
L Depth 12" (305)
L Height 5 1/2" (140)

TELFORD ANDIRONS

Width 9 1/2" (240)
Depth 24 1/4" (617)
Height 17" (432)



An additional 6 1/4" (158) must be added to the overall widths of all the baskets for dogs to allow for support arms. Fire baskets are supplied with gas control covers but not ash pans.

1 FARADAY

Width 7" (177)
Depth 19 1/2" (495)
Height 12 5/8" (321)

3 BEVAN

Width 6 1/2" (166)
Depth 21 3/8" (543)
Height 12 5/8" (321)

5 BURTON

Width 9 1/2" (242)
Depth 20 1/4" (514)
Height 17 1/8" (436)

2 NEWTON

Width 7" (177)
Depth 20 5/8" (524)
Height 17" (432)

4 TELFORD

Width 9 1/2" (240)
Depth 24 1/4" (617)
Height 17" (432)



Flue Soundness & Requirements

Before the fire is installed, the chimney should be swept and a flue test in accordance with National Regulations should be carried out.

Flues for DFE gas fires must comply with BS5871-3/BS5440-1 to be used unlined.

The flue must be fitted in accordance with National Regulations, damper plates or flue restrictors must be removed or fixed permanently in the fully open position.

Builders opening and fire chamber must be constructed of non-combustible material. The minimum flue diameter is 178mm (7") diameter, 250 sq. cm. (38.5 sq. inches). An in-line fan that complies with BS5440: Part 1 can be used to improve flue draught.

NOTE - The flue must not be shared with any other appliance.

This appliance must not be fitted in any room where steam is present (e.g Bathroom/swimming pool).

It is advised not to stand too close to the appliance for prolonged periods of time; loose clothing is particularly at risk of burning due to the presence of an unguarded flame. It is also advised against placing combustible materials directly in front of the appliance. Floor coverings such as carpets, are considered to be acceptable.

Due to the newness of materials, the fire may give off a slight smell for a period of time after commissioning. This is quite normal and any odours should dissipate within a few hours of operation.

Ventilation

Ensure the room where the appliance is to be fitted has suitable ventilation. The size and type of ventilation should take into account any other gas appliance in the room. The room where the appliance is to be fitted must have a permanent air vent to the outside air in accordance with Local and National Regulations. The air vent must be checked on a regular basis to ensure there is no obstruction.

Fitting the Fire Unit

An isolation valve or valves must be fitted adjacent to the appliance in accordance with National Regulations. This is to allow the complete removal of the burner control assembly, for maintenance or repair.

Tempering of Steel Baskets & Register Grates

Polishing with WD-40 and fine wire wool is highly recommended on a periodic basis. The areas of the basket or register grate near the burning area are subject to 'tempering' which is discolouration of the metal, this is normal and not a problem.

Gas Fire and Basket/Grate Compatibility

GAS FIRE UNIT	COMPATIBLE FIRE BASKETS/REGISTER GRATES
CUBB18	ABERDEEN 18", AMHURST 18", BAIRD 18" (FREESTANDING & FOR DOGS), BYRON 18" (FREESTANDING & FOR DOGS), CAXTON 18" (FREESTANDING & FOR DOGS), DUCKSNEST 18" (FREESTANDING & FOR DOGS), FIBONACCI 18", MORRIS 18" (FREESTANDING & FOR DOGS), OSBORNE 18", POPULAR 18", TYNDALE 18" (FREESTANDING & FOR DOGS), SOHO 18" (FREESTANDING & FOR DOGS)
CUBB22	ABERDEEN 22", AMHURST 22", BAIRD 22" (FREESTANDING & FOR DOGS), BYRON 22" (FREESTANDING & FOR DOGS), CAXTON 22" (FREESTANDING & FOR DOGS), DUCKSNEST 22" (FREESTANDING & FOR DOGS), FIBONACCI 22", MORRIS 22" (FREESTANDING & FOR DOGS), OSBORNE 22", POPULAR 22", TYNDALE 22" (FREESTANDING & FOR DOGS), SOHO 22" (FREESTANDING & FOR DOGS)
CR1	GEORGIAN REGISTER GRATE
CR2	ORNATE ARCH REGISTER GRATE, PLAIN ARCH REGISTER GRATE
CR3	GODWIN REGISTER GRATE
CR4	BRITTON NO.1, NO.3 & NO.4 ARCH REGISTER GRATES
CR5	CADOGAN BASKET, STANHOPE BASKET
CR6	ANDOVER REGISTER GRATE
CR8	OSTERLEY BASKET, SYON BASKET

Basket and register grate models not listed above will have a standard gas fire and not a Chesney's Alchemy gas fire. Please ask for further information.

Coal and Log Compatibility

NATURAL GAS		
GAS FIRE UNIT	COALS	CHESNEY'S LOGS
CUBB18	✓	✓
CUBB22	✓	✓
CR1, CR2, CR3, CR4, CR6	✓	✗
CR5, CR8	✓	✓

LPG		
GAS FIRE UNIT	COALS	CHESNEY'S LOGS
CUBB18	✓	✗
CUBB22	✓	✗
CR1, CR2, CR3, CR4, CR5, CR6, CR8	✓	✗

Gas Category, Type and Supply Pressure

Natural Gas

GAS FIRE UNIT	COUNTRY OF DESTINATION																													
	GB	US	AT	BE	CH	CY	CZ	DE	DK	EE	ES	FI	FR	GR	HU	IE	IT	LT	LU	LV	NL	NO	PL	PT	RO	SE	SI	SK	TR	
CUBB18	A	✘	A	B	A	✘	A	C	A	A	A	A	B	A	✘	A	A	A	C	A	✘	A	C	A	A	A	A	A	A	A
CUBB22	A	✓	A	B	A	✘	A	C	A	A	A	A	B	A	✘	A	A	A	C	A	✘	A	C	A	A	A	A	A	A	A
CR1, CR2, CR3, CR4, CR5, CR6, CR8	A	✘	A	B	A	✘	A	C	A	A	A	A	B	A	✘	A	A	A	C	A	✘	A	C	A	A	A	A	A	A	A

KEY	
A	I _{2H} - G20 AT 20 MBAR
B	I _{2E+} - G20/G25 AT 20-25 MBAR
C	I _{2E} - G20 AT 20 MBAR
✘	NOT TESTED

Liquid Propane Gas (LPG)

GAS FIRE UNIT	COUNTRY OF DESTINATION																												
	GB	US	AT	BE	CH	CY	CZ	DE	DK	EE	ES	FI	FR	GR	HU	IE	IT	LT	LU	LV	NL	NO	PL	PT	RO	SE	SI	SK	TR
CUBB18	A B C	✘	✘	A B C	A B	B C	A B	B	C	C	A B C	C	A B C	A B C	C	A B	A B	C	✘	✘	C	C	✘	✘	C	C	A B C	A B C	A C
CUBB22	A B C	✘	✘	A B C	A B	B C	A B	B	C	C	A B C	C	A B C	A B C	C	A B	A B	C	✘	✘	C	C	✘	✘	C	C	A B C	A B C	A C
CR1	B C	✘	✘	B C	B	B C	B	B	C	C	B C	C	B C	B C	C	B	B	C	B C	B C	C	C	B C	B C	C	C	B C	B C	C
CR2, CR3, CR4, CR5, CR6, CR8	A B C	✘	✘	A B C	A B	B C	A B	B	C	C	A B C	C	A B C	A B C	C	A B	A B	C	✘	✘	C	C	✘	✘	C	C	A B C	A B C	A C

KEY	
A	I _{3P} - G31 AT 37 MBAR
B	I ₃₊ - G30/G31 AT 28-30 / 37 MBAR
C	I _{3B/P} - G30/G31 AT 30 MBAR
✘	NOT TESTED

Notes

A number of the Alchemy gas fires in this brochure have been installed with hand carved chimneypieces from Chesney's range of period and contemporary stone and marble fire surrounds. This is widely acknowledged as the leading collection of its kind in the world, and also includes a wide selection of fire baskets, fire dogs, andirons, fire tools and register grates. Separate full colour brochures are available illustrating these ranges.

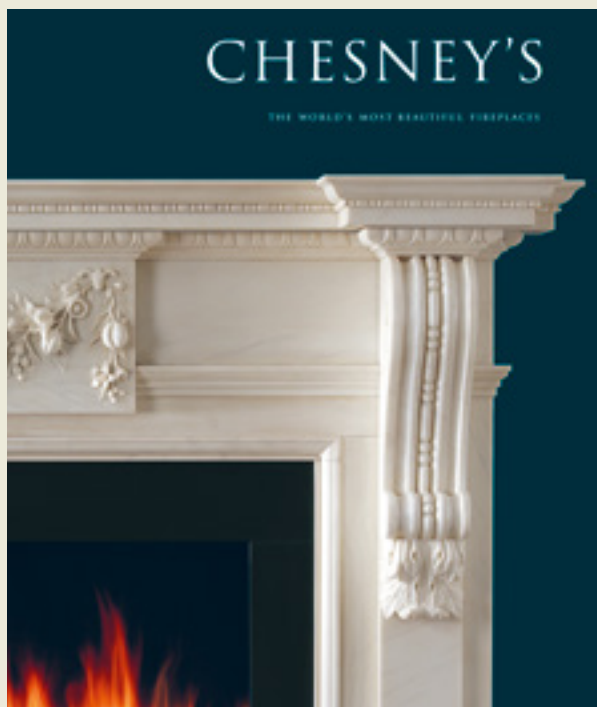

Acknowledgements

Anthony Parkinson Photography

www.anthonyparkinsonphotography.com
Photography

Farrow & Ball

www.farrow-ball.com
Hardwick White page 3
Off White page 6-7
Old White pages 7 & 14

Fired Earth

www.firedearth.com
Scarab page 16

Kingcome Sofas

www.kingcomesofas.co.uk
Richmond Stool pages 8 & 14

The Natural Curtain Company

www.naturalcurtaincompany.co.uk
Curtains pages 8 & 14

Paint & Paper Library

www.paintlibrary.co.uk
Slate V pages 13 & 27
Tarlatan pages 11 & 24

Tom Faulkner

www.tomfaulkner.co.uk
Tables page 3

Victorian Woodworks

www.victorianwoodworks.co.uk
Wooden Floor page 13

© Chesney's MMXIV August 2014

Chesney's pursues a policy of continuing improvement in design and performance of its products. The right is therefore reserved to vary specifications without notice.

* Some natural heat discolouration may take place over time.

Showrooms

London

194-200 Battersea Park Road,
London SW11 4ND
Telephone 020 7627 1410
Fax 020 7622 1078

Email: sales@chesneys.co.uk

Architectural Showroom:
521-525 Battersea Park Road,
London SW11 3BN
Telephone 020 7978 7224
Email: architecturalservices@chesneys.co.uk

For details of UK nationwide stockists:
Telephone 0844 880 5375
Fax 0844 376 0046
Email: dealerenquiries@chesneys.co.uk

www.chesneys.co.uk

New York

Suite 1119, 11th Floor,
D&D Building, 979 Third Avenue,
New York NY 10022
Telephone 001 646 840 0609
Fax 001 646 840 0602
Email: newyorksales@chesneys-usa.com

For details of US nationwide stockists:
001 404 948 1111

www.chesneys.com

CHESNEY'S

ALCHEMY DFE GAS FIRES	£	FIRE BASKETS	£	REGISTER GRATES	£
Coal effect - manually operated	from 550.00	Adam steel or brass	2830.00	Cubitt 36	1375.00
Coal effect - remote control	from 850.00	Croome steel	2670.00	Cubitt 40	1475.00
Log effect - manually operated	from 720.00	Croome brass	3415.00	Campbell	1995.00
Log effect - remote control	from 1020.00	Syon steel	2260.00	Chamberlain	2750.00
Set of Alchemy Coals	60.00	Syon brass	3100.00	Hardwick	2750.00
Set of Alchemy Logs	170.00	Osterley steel	2260.00	Hawksmoor	3250.00
		Osterley brass	3100.00	Godwin	725.00
FORGED BASKETS & ANDIRONS		Dorchester steel or brass	815.00	Plain Arched	1250.00
Baird 18" and 22"	495.00	Cadogan steel or brass	560.00	Ornate Arched	1250.00
Byron 18" and 22"	495.00	Stanhope steel or brass	685.00	Britton No.1, No.3 & No.4 Arched	595.00
Caxton 18" and 22"	495.00	Adam No.2	625.00	Lincoln's Inn Half Hob	825.00
Morris 18" and 22"	495.00	Aberdeen 18" and 22"	675.00		
Tyndale 18" and 22"	495.00	Popular 18" and 22"	395.00		
Bevan andirons	675.00	Fibonacci 18" and 22"	395.00		
Burton andirons	495.00	Soho Freestanding 18" and 22"	395.00		
Faraday andirons	580.00	Soho for Dogs 18" and 22"	395.00		
Newton andirons	495.00	Amhurst 18" and 22"	395.00		
Telford andirons	495.00	Osborne 18" and 22"	395.00		
		Ducksnest Freestanding 18" and 22"	395.00		
		Ducksnest for Dogs 18" and 22"	345.00		
		Swansnest for Dogs 18" and 22"	345.00		
		Stone Bowl	1025.00		
		FIRE DOGS			
		Ballhead	345.00		
		Faulkner	345.00		
		Spherical Steel	345.00		
		Modi	495.00		
		Obelisk	375.00		
		Swan	1550.00		

All prices are exclusive of VAT, delivery and installation.

Installation prices are subject to site visit. See brochure for details of sizes.