

Global fires

GAS FIRES 2018



MADE IN BRITAIN





Welcome to Global

At Global Fires we know how important it is to create a stylish and relaxing living environment. That's why we've developed this collection of versatile and affordable gas fires to complement all tastes and lifestyles.



I believe our success stems from a combination of innovative design, investment in technology and the highest quality manufacturing standards. As a result all Global fires carry a 10 year guarantee to reflect my belief in their quality and durability, and our experienced Global retailers are hand-picked to give you the very best advice and service.

This brochure has been designed to make the purchase of your new Global fire as simple as possible. I hope you will find it both informative and inspiring.

A handwritten signature in black ink that reads "Michael Jones".



Today BFM Europe is the fastest growing domestic fire producer in the country with an unequalled reputation for quality and services. Every Global branded gas fire is developed and manufactured in Britain at our purpose built, state-of-the-art facility in Stoke-on-Trent.





10 Year Guarantee

All Global gas fires carry the peace of mind of a 10 year Guarantee and the reassurance of a flame supervision device on all models. This device prevents the uncontrolled release of gas to the burner.

Our 10 year Guarantee is subject to terms and conditions including annual services and annual replacement of the oxy-pilot assembly carried out by a Gas Safe Register engineer.



Product Testing & Certification

All our gas fires are independently tested, approved and verified by the British Standards Institution (BSI) to meet the latest standards for performance, safety and efficiency.

The BSI is an independent organisation. They are not owned by the government, industry or shareholders, which means that they can be totally objective with regards testing and certification. This gives their assessments more authority than those of an organization that has a vested interest in promoting its members.

They have some of the most experienced and knowledgeable staff in the world and are recognised internationally for their technical expertise, quality services and in-depth knowledge of gas and electrical product testing and certification.

The wide-ranging capability of their testing facilities and the broad expertise and knowledge of their testing and certification staff ensures our products are rigorously tested with the utmost integrity.



Ecodesign compliant

This logo signifies that the product is fully compliant with the Eco design directive Commission Regulation (EU) 2015/1188.



Contents



Using this brochure

Before you begin please take a moment to read page 6 and establish the type of chimney or flue you have in your home and the control type which would be most suitable for your needs. As you browse through our product range you can easily identify if a gas fire is suitable for you by checking the icons on each page.

Unless otherwise stated, our hearth inset fires come complete with a Profiled trim in your choice of brass, polished silver, brushed silver or black finish. Complete the look of your chosen fire with any of our 6 stylish fret designs. You may also be able to upgrade to a different trim, or for a more modern look, one of our contemporary fascias. See pages 24-25 to find out which accessories are suitable for your chosen fire.

high efficiency

Conventional Flue

Wall Inset – Glass Fronted

Delta HE..... 7

Hearth Inset – Glass Fronted

Passion HE..... 8-9

Saranda HE..... 10

Karara HE..... 11

Fantasy HE..... 12

Delta HE..... 13

Hearth Inset – Open Fronted

Fantasy Plus 14

Arana Plus 15

Corda Plus 16

Arana 17

Balanced Flue

Hearth Inset – Glass Fronted

Fantasy BF 18

Corda BF 19

Welcome to Global 2-3

Contents 4

Efficiencies..... 5

Before you begin 6

standard fires

Conventional and Powerflue

Hearth Inset – Open Fronted

Corda 20

Karara 21

Delta 22

Fantasy & Fantasy Powerflue..... 23

Accessories

Trims & Frets..... 24

Fascias..... 25

Powerflue

Installation Possibilities..... 26

Online inspiration..... 27

high efficiency

Get up to **93.5%** energy efficiency from your gas fire...

Global Fires have set new industry standards with the introduction of the high efficiency range: exceptional heat output combined with lower running costs compared to standard gas fires.

Our team has invested in developing the technology to meet the key objective of producing gas fires that save energy and as a result, help to keep costs down.

Conventional Flue Fires

Glass Fronted Fires



Saranda HE 86%..... 10

Our range of high efficiency conventional flue glass fronted fires have an energy efficiency of up to 86%. They have a glass panel across the front of the fire which radiates the heat generated from the fuel bed directly into the room. The glass panel concentrates the radiant heat so that more heat is forced into the room and less is lost through the chimney. Combined with convected heat which is produced by cool air drawn into the base of the fire through the heat exchanger and then emitted as warm air through the gap above the canopy, making these the most efficient conventional flue fires available.

Open Fronted Fires



Fantasy Plus 68.3%..... 14

Our high efficiency conventional flue open fronted fires can reach an energy efficiency of up to 68.3%. These fires provide the look and feel of a real open fire providing both radiant and convected heat. Radiant heat is emitted from the coal effect fuel bed and the convected heat is generated by cool air drawn into the base of the fire which passes through a heat exchanger and is then emitted as warm air through the gap above the canopy.

Balanced Flue Fires

Glass Fronted Fires



Fantasy BF 93.5% 18

Our range of high efficiency balanced flue fires have an energy efficiency of up to 93.5%. Designed for those who want all the benefits of a gas fire but don't have a built in chimney or flue in their home, a balanced flue fire comes with its own flue terminal which is vented directly through an outside wall. They are glass fronted, completely room sealed appliances and work by drawing and venting external air via a pair of co-axial tubes into the fire for combustion purposes.

standard fires

Conventional and Powerflue Fires

Open Fronted Fires



Corda 53.1% 20

Standard fires can achieve a direct heat output of up to 3.1kW. However these products are not suitable for use as a primary heat source.

Before you begin...

Type of Chimney or Flue

The type of chimney or flue you have dictates the type of fire you can have. But if you're not sure, then take a look at your roof and compare it with the simple guide below. It's worth remembering that a full depth fire often requires a traditional chimney or rebate on the fire surround, whilst a slimline fire will fit virtually any chimney or flue.



Brick Chimney

Apart from products designed for 'no chimney' applications, all Global products will fit brick chimneys. They are easily recognisable by a chimney stack with accompanying terracotta pot or gas terminal.



Pre-Fabricated Flue

Pre-fabricated flues are easily identifiable by a metal flue and terminal on the roof and a metal flue box behind the fire.

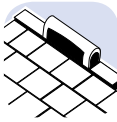

Pre-Cast Flue

Pre-cast flues can be identified by a ridge vent or metal flue tube and terminal on the roof. Constructed from concrete or clay blocks they form a rectangular section flue. All Global fires featuring this icon are only suitable for pre-cast flues conforming to BS EN 1858.

Can't see a Chimney or Flue?

If you can't see a chimney or flue like the ones described above, then you will require either a Balanced Flue, a Powerflue or an electric fire.



Powerflue

Powerflue fires use an electronically driven fan unit inset on the external wall to expel the flue gases directly outside the building.

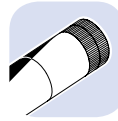

Balanced Flue

Balanced Flue fires use a horizontal pipe to vent directly outside. An electricity supply is not required for Balanced Flue products.

Controls



Manual Control

Simple and discreet. The control system is located behind the fire's fret or trim. Once the fire is lit rotate the control knob to adjust the flame height and heat output.

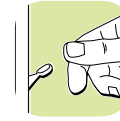

Slide Control

A convenient control system which is located on the top right-hand side of the fire. Push and hold the lever down to ignite and move it up and down to adjust the flame height and heat output.

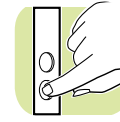

Easy Flame Control (EFC)

Discreet, easy access buttons are used to ignite the fire and adjust heat and flame height.



Remote Control

The remote control handset is used to light the fire as well as to adjust the flame height and heat output.



Remote Control with Thermostat

The remote control handset can be used to light the fire as well as to adjust the flame height and heat output. In addition, the handset contains the extra benefit of a thermostatic control to regulate room temperature and a programmable timer that can be pre-programmed to ensure your room will be warm whenever you wish.

Fuel Bed Effects



Coal



Pebble



Log

Back Panels



Plain Black



Glossy Black Enamel



Brick Effect

Gas Supply

Your gas supply will depend on the area in which you live.



Natural Gas

If you have a gas meter then you will have natural gas.



LPG

Alternative for houses with no natural gas supply.

high efficiency Conventional Flue

Wall Inset – Glass Fronted



Delta HE

This portrait hole-in-the-wall fire features a striking polished silver fascia and a 3.4kW heat output. The Delta HE wall inset is the ideal solution for smaller rooms where space is at a premium.

The glass fronted Delta HE is operated by thermostatic remote control and comes with a coal fuel bed. A pebble fuel effect is available as an optional extra.

Specifications

Description: Full depth inset gas fire
Type of Heat: Radiant & Convected

| | |
|--------------------------|-------------|
| Useful energy efficiency | 84.3% |
| Energy efficiency class | C |
| Fuel type | Natural gas |
| Direct heat output | 3.4kW |

| Fuel effect | Control type | Model Number |
|-------------|--------------|--------------|
| Coal | Remote | GHKC56RN3 |

Safety: Flame Supervision Device & Oxygen Depletion Sensor
Air vent required: Not normally

Dimensions

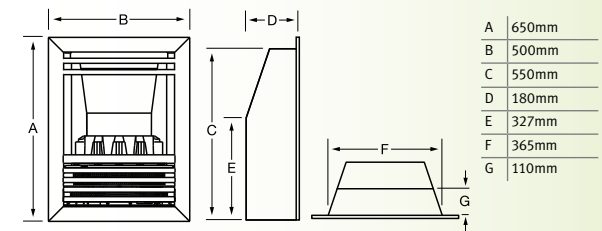

Delta HE Wall Inset with pebble effect fuel bed

Delta HE Wall Inset with coal



Natural Gas



Brick Chimney



Pre-Fabricated



Thermostatic Remote



Coal



Pebble



Plain Black

Passion HE



The Passion HE is a beautiful gas fire with a truly authentic looking log effect fuel bed. With its large viewing window it features stunning flame motion that captivates as it dances and reflects in the glossy black enamel interior.

For optimum aesthetics this fire can be supplied with non reflective glass that provides an astonishingly crystal clear view of the fuel bed. For comfort and performance choose our fully automatic and thermostatic remote control option. A manual control version is also available.



Passion HE with Ultimo 007 fascia in Gold

Also available in Black Nickel and Silver finish

The Passion HE is available with a choice of specifically designed contemporary one-piece fascia options, the Ultimo 007 in three colour finishes, gold, black nickel and silver, and the Provence cast iron fascia in black.

For a more traditional two-piece arrangement we have introduced a uniquely designed Bauhaus 151 fret. Combine this with the tasteful Ultimo trim to further complement the wide viewing angles of this fire. Alternatively you can combine this fret with other Global trim options – see page 24.



Passion HE Ultimo trim and Bauhaus 151, shown in Silver

Also available in Black Nickel and Gold finish



Passion HE Ultimo trim and Bauhaus 151, shown in Black Nickel

Also available in Gold finish

Specifications

Description: Full depth inset gas fire
Type of Heat: Radiant & Convected

| | Manual | Remote | |
|--------------------------|-------------|-------------|-------|
| Useful energy efficiency | 82.3% | 82.6% | 79.7% |
| Energy efficiency class | D | C | D |
| Fuel type | Natural gas | Natural gas | LPG |
| Direct heat output | 4.0kW | 4.0kW | 3.6kW |

| Fuel effect | Control type | Model Number | |
|-------------|--------------|--------------|----------|
| Log | Manual | GLBL00MN | n/a |
| | Remote | GLBL00RN | GLBL00RP |

Safety: Flame Supervision Device & Oxygen Depletion Sensor
Air vent required: Not normally

Dimensions

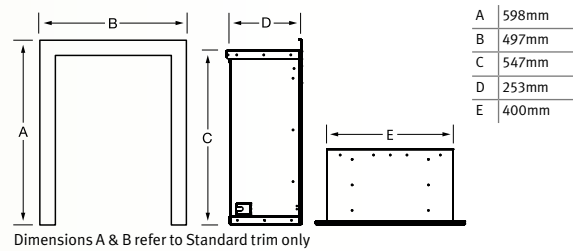

Passion Fascias

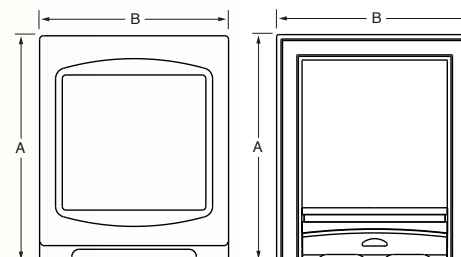

*Remote control option only

| Provence* | Ultimo 007 |
|-----------|------------|
| A 614mm | A 613mm |
| B 532mm | B 516mm |



Watch the video

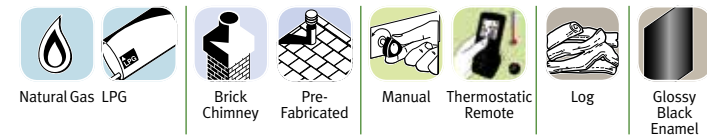



Passion HE with Provence black cast iron fascia (available with remote control only)

high efficiency Conventional Flue

Hearth Inset – Glass Fronted

Saranda HE



If you're looking for a gas fire with efficiency in mind this has to be the product for you. The Saranda HE glass fronted fire features our most realistic full depth coal effect fuel bed and boasts an energy efficiency of 86%. With an impressive 3.9kW output the Saranda HE keeps your heat high and your fuel costs low. You can choose your preferred trim and fret combination to suit your decor – see pages 24 & 25.

Specifications

Description: Full depth inset gas fire
Type of Heat: Radiant & Convected

| | Manual/Slide | Remote |
|--------------------------|--------------|-------------|
| Useful energy efficiency | 86% | 86% |
| Energy efficiency class | C | C |
| Fuel type | Natural gas | Natural gas |
| Direct heat output | 3.9kW | 3.9kW |

| Fuel effect | Control type | Model Number |
|-------------|--------------|--------------|
| Coal | Manual | GHEC00MN |
| | Slide | GHEC00SN |
| | Remote | GHEC00RN2 |

Safety: Flame Supervision Device & Oxygen Depletion Sensor
Air vent required: Not normally

Dimensions

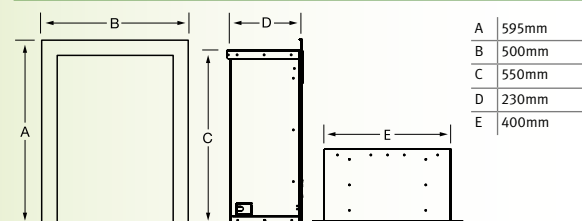

| | |
|---|-------|
| A | 595mm |
| B | 500mm |
| C | 550mm |
| D | 230mm |
| E | 400mm |

Dimensions A & B refer to Profiled trim only



Saranda HE with Arcadia fascia in gold

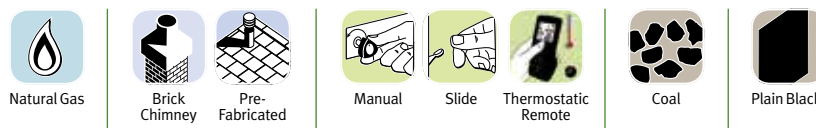

high efficiency Conventional Flue

Hearth Inset – Glass Fronted



Karara HE

The slimline Karara HE is the high energy efficiency solution for almost any flue type. Suitable for brick chimney, pre-fabricated and pre-cast flues, this glass fronted product delivers an amazing 2.9kW heat output and has an energy efficiency of 81.3%.

Accessorise your fire with your choice of fascia or trim and fret combination from our large selection (see pages 24 & 25).

A pebble fuel effect is available as an optional extra.

Specifications

Description: Slimline inset gas fire
Type of Heat: Radiant & Convected

| | |
|--------------------------|-------------|
| Useful energy efficiency | 81.3% |
| Energy efficiency class | D |
| Fuel type | Natural gas |
| Direct heat output | 2.9kW |

| Fuel effect | Control type | Model Number |
|-------------|--------------|--------------|
| Coal | Manual | GSHC00MN |
| | Slide | GSHC00SN2 |

Safety: Flame Supervision Device & Oxygen Depletion Sensor
Air vent required: Not normally

Dimensions

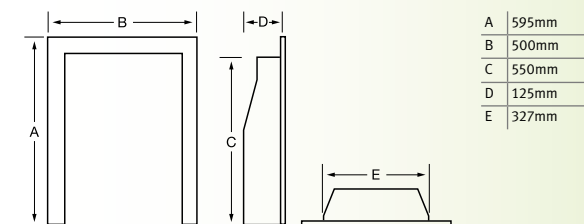

Dimensions A & B refer to Profiled trim only.



Karara HE with coal effect fuel bed and Contemporary brushed steel fascia

Karara HE with pebble



Natural Gas



Brick Chimney



Pre-Fabricated



Pre-Cast



Manual



Slide



Coal



Pebble



Plain Black

high efficiency Conventional Flue

Hearth Inset – Glass Fronted



Fantasy HE

The Fantasy HE features a highly realistic full depth fuel bed and will fit most chimney and flue applications, including pre-cast when fitted with a 3” rebated surround. This glass fronted fire provides an impressive 3.4kW heat output and 84.3% energy efficiency. With a coal fuel effect and manual, slide or thermostatic remote control, you will certainly find a model to suit your taste and needs. A pebble fuel effect is also available as an optional extra.

Specifications

Description: Full depth inset gas fire
Type of Heat: Radiant & Convected

| | Manual/Slide | Remote |
|--------------------------|--------------|-------------|
| Useful energy efficiency | 84.3% | 84.3% |
| Energy efficiency class | D | C |
| Fuel type | Natural gas | Natural gas |
| Direct heat output | 3.4kW | 3.4kW |

| Fuel effect | Control type | Model Number |
|-------------|--------------|--------------|
| Coal | Manual | GHKCO0MN2 |
| | Slide | GHKCO0SN2 |
| | Remote | GHKCO0RN3 |

Safety: Flame Supervision Device & Oxygen Depletion Sensor
Air vent required: Not normally

Dimensions

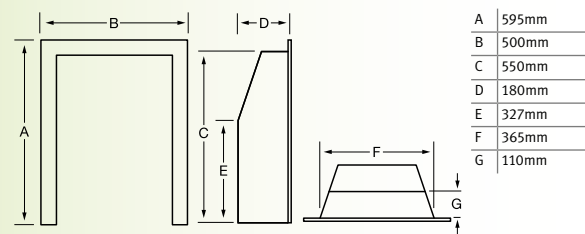

Dimensions A & B refer to Profiled trim only.



Fantasy HE pebble and Contemporary Deluxe fascia

Fantasy HE coal and Contemporary Deluxe fascia in black



Natural Gas



Brick Chimney



Pre-Fabricated



Pre-Cast



Manual



Slide



Thermostatic Remote



Coal



Pebble



Plain Black



Delta HE Hearth Inset with coal effect fuel bed



Delta HE Hearth Inset with pebble



Natural Gas



Brick Chimney



Pre-Fabricated



Pre-Cast



Manual



Slide



Thermostatic Remote



Coal



Pebble



Plain Black

high efficiency Conventional Flue

Hearth Inset – Glass Fronted



Delta HE

The glass fronted Delta HE features an ultramodern polished silver fascia and with an energy efficiency of 64.3% is the perfect fire for modern day living. This highly sophisticated gas fire can be purchased as a manual, slide or thermostatic remote control fire with a coal fuel bed. A pebble fuel effect is available as an optional extra.

Specifications

Description: Full depth inset gas fire
Type of Heat: Radiant & Convected

| | Manual/Slide | Remote |
|--------------------------|--------------|-------------|
| Useful energy efficiency | 64.3% | 64.3% |
| Energy efficiency class | D | C |
| Fuel type | Natural gas | Natural gas |
| Direct heat output | 3.4kW | 3.4kW |

| Fuel effect | Control type | Model Number |
|-------------|--------------|--------------|
| Coal | Manual | GHKC34MN2 |
| | Slide | GHKC37SN2 |
| | Remote | GHKC34RN3 |

Safety: Flame Supervision Device & Oxygen Depletion Sensor
Air vent required: Not normally

Dimensions

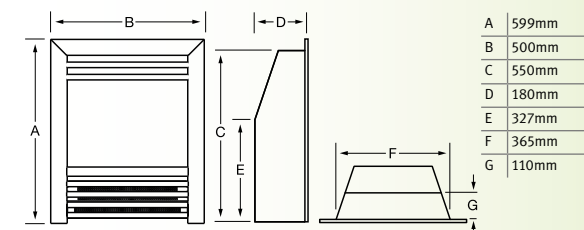

high efficiency Conventional Flue

Hearth Inset – Open Fronted

Fantasy Plus



The Fantasy Plus boasting an amazing 68.3% energy efficiency can be installed in to almost any chimney or flue, including pre-cast when fitted with a 3" rebated fire surround. This open-fronted gas fire features a highly realistic coal fuel effect and is available as a manual, slide or remote controlled fire.

Specifications

Description: Full depth inset gas fire
Type of Heat: Radiant & Convected

| | |
|--------------------------|-------------|
| Useful energy efficiency | 68.3% |
| Energy efficiency class | F |
| Fuel type | Natural gas |
| Direct heat output | 4.2kW |

| Fuel effect | Control type | Model Number |
|-------------|--------------|--------------|
| Coal | Manual | GKPC00MN |
| | Slide | GKPC00SN |
| | Remote | GKPC00RN2 |

Safety: Flame Supervision Device & Oxygen Depletion Sensor
Air vent required: Not normally

Dimensions

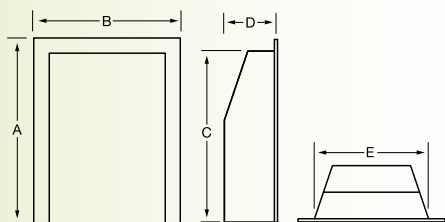

| | |
|---|-------|
| A | 600mm |
| B | 498mm |
| C | 548mm |
| D | 170mm |
| E | 365mm |

Dimensions A & B refer to Profiled trim only.



Fantasy Plus with Curved silver trim and Grace silver fret



Natural Gas



Brick Chimney



Pre-Fabricated



Pre-Cast



Manual



Slide



Remote



Coal



Plain Black



Arana Plus with Profiled brass trim and Elegance Brass fret



Natural Gas



Brick Chimney



Pre-Fabricated



Manual



Slide



Remote



Coal



Plain Black

high efficiency Conventional Flue

Hearth Inset – Open Fronted



Arana Plus

The Arana Plus is our first full depth open-fronted high efficiency gas fire. You can now achieve the look of a real open coal fire at an incredible 66.7% energy efficiency. Suitable for installation into standard chimneys the Arana Plus comes in a choice of manual, slide or remote control and can be styled to suit your home with our wide range of trims and frets.

See pages 24 & 25.

Specifications

Description: Full depth inset gas fire
Type of Heat: Radiant & Convected

| | |
|--------------------------|-------------|
| Useful energy efficiency | 66.7% |
| Energy efficiency class | F |
| Fuel type | Natural gas |
| Direct heat output | 4.1kW |

| Fuel effect | Control type | Model Number |
|-------------|--------------|--------------|
| Coal | Manual | GOPC00MN |
| | Slide | GOPC00SN |
| | Remote | GOPC00RN2 |

Safety: Flame Supervision Device & Oxygen Depletion Sensor
Air vent required: Not normally

Dimensions

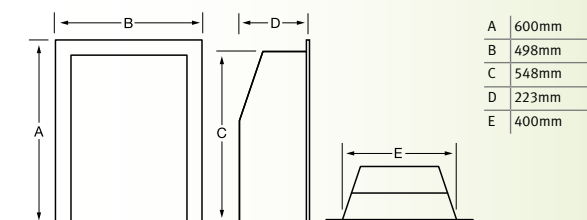

Dimensions A & B refer to Profiled trim only

high efficiency Conventional Flue

Hearth Inset – Open Fronted



Corda Plus

The Corda Plus is one of the most efficient open-fronted slimline gas fires available today and with a heat output of up to 4kW it is also one of the warmest products suitable for a pre-cast flue.

The Corda Plus is available in a choice of manual, remote or our easy access Easy Flame control systems. This extremely versatile fire can be styled with a wide range of Global trims, frets or fascias and with an optional pebble fuel bed it is easy to create a look to suit your existing décor.

Specifications

Description: Slimline inset gas fire
Type of Heat: Radiant & Convected

| | Manual | Easy Flame/Remote |
|--------------------------|-------------|-------------------|
| Useful energy efficiency | 66.8% | 66.8% |
| Energy efficiency class | F | F |
| Fuel type | Natural gas | Natural gas |
| Direct heat output | 4.0kW | 3.8kW |

| Fuel effect | Control type | Model Number |
|-------------|--------------|--------------|
| Coal | Manual | GSPC00MN |
| | Easy Flame | GSPC00TN2 |
| | Remote | GSPC00RN2 |

Safety: Flame Supervision Device & Oxygen Depletion Sensor
Air vent required: Not normally

Dimensions

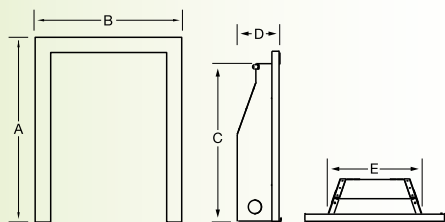

| | |
|---|-------|
| A | 600mm |
| B | 498mm |
| C | 548mm |
| D | 125mm |
| E | 324mm |

Dimensions A & B refer to Standard trim only



Corda Plus with Deluxe Contemporary fascia in brushed silver



Natural Gas



Brick Chimney



Pre-Fabricated



Pre-Cast



Manual



EFC



Remote



Coal



Pebble



Plain Black



Arana with Profiled brass trim and Bauhaus brass fret



Natural Gas



Brick Chimney



Pre-Fabricated



Manual



Slide



Coal



Plain Black

high efficiency Conventional Flue

Hearth Inset – Open Fronted



Arana

The Arana features one of the most realistic coal effects on the market and offers an amazing 3.7kW of heat. This open fronted fire is able to deliver a higher output through the use of a heat exchanger which draws in the cool room air and converts it to warm convected air.

Manual and slide control models are available and you can create your own style with a choice of any Global trim, fret or fascia (see pages 24 & 25).

Specifications

Description: Full depth inset gas fire
Type of Heat: Radiant & Convected

| | |
|--------------------------|-------------|
| Useful energy efficiency | 60% |
| Energy efficiency class | F |
| Fuel type | Natural gas |
| Direct heat output | 3.7kW |

| Fuel effect | Control type | Model Number |
|-------------|--------------|--------------|
| Coal | Manual | GICCO0MN |
| | Slide | GICCO0SN |

Safety: Flame Supervision Device & Oxygen Depletion Sensor
Air vent required: Not normally

Dimensions

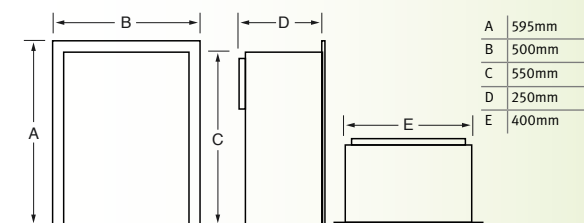

Dimensions A & B refer to Profiled trim only

high efficiency Balanced Flue

Hearth Inset – Glass Fronted



Fantasy BF

The Fantasy Balanced Flue is the perfect solution for those who like the look of a full depth fire but don't have a standard chimney or flue in their home. With 93.5% energy efficiency, this glass fronted fire is the most efficient product in our range and offers an impressive 3.9kW heat output.

The Fantasy BF comes in a choice of manual, Easy Flame or thermostatic remote control (see page 6 for more details), and can be teamed with a large number of Global trims and frets including the Delta contemporary one-piece fascia (see pages 24 & 25). This fire can be installed easily into most standard cavity walls when fitted with a 3" rebated fire surround.

Specifications

Description: Full depth inset gas fire
Type of Heat: Radiant & Convected

| | Manual | Easy Flame | Remote |
|--------------------------|-------------|-------------|-------------|
| Useful energy efficiency | 93.5% | 93.5% | 93.5% |
| Energy efficiency class | B | B | B |
| Fuel type | Natural gas | Natural gas | Natural gas |
| Direct heat output | 3.9kW | 3.9kW | 3.9kW |

| Fuel effect | Control type | Model Number |
|-------------|--------------|--------------|
| Coal | Manual | GBFC00MN2 |
| | Easy Flame | GBFC00EN3 |
| | Remote | GBFC00RN3 |

Safety: Flame Supervision Device
Air vent required: No

Dimensions

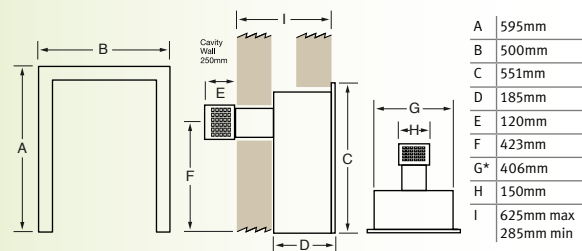

Dimensions A & B refer to Profiled trim only. *Dimensions differ on Easy Flame control models. Please refer to installation manual. An optional flue extension is available to increase the maximum flue length to 1010mm on manual models and 973mm on Easy Flame models.



Fantasy Balanced Flue with Profiled black trim and Aegis black fret



Natural Gas



Balanced Flue



Manual



EFC



Thermostatic Remote



Coal



Plain Black



Corda Balanced Flue with brass trim and Balmoral brass fret

high efficiency Balanced Flue

Hearth Inset – Glass Fronted



Corda BF

The super slim Corda Balanced Flue has been specifically designed for homes without a chimney and its slim depth allows it to be easily installed into a standard cavity wall. This glass fronted product has an incredible 80% energy efficiency and comes with a choice of brass or chrome trim which can be complemented with your choice of any Global fret (see pages 24 & 25).

Specifications

Description: Slimline inset gas fire
Type of Heat: Radiant & Convected

| | |
|--------------------------|-------------|
| Useful energy efficiency | 80% |
| Energy efficiency class | E |
| Fuel type | Natural gas |
| Direct heat output | 2.7kW |

| Fuel effect | Control type | Trim | Model Number |
|-------------|--------------|--------|--------------|
| Coal | Manual | Brass | GBFC10MN |
| | | Chrome | GBFC30MN |

Safety: Flame Supervision Device
Air vent required: Not normally

Dimensions

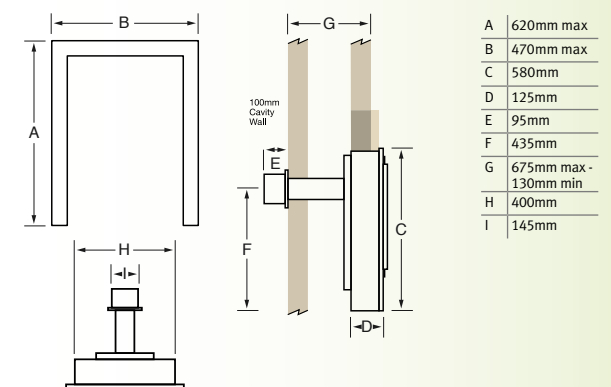

Natural Gas



Balanced Flue



Manual



Coal



Brick Effect

Corda



The slimline Corda gas fire features an attractive coal fuel bed and dancing flame effect. It is suitable for installation in to almost any home, to fit a standard brick chimney, pre-fabricated flue or pre-cast (BS EN 1858).

It is available in a choice of manual or convenient slide control. See pages 24-25 for trim and fret combinations.

Specifications

Description: Slimline inset gas fire
Type of Heat: Radiant

| | |
|--------------------------|-------------|
| Useful energy efficiency | 53.1% |
| Energy efficiency class | F |
| Fuel type | Natural gas |
| Direct heat output | 3.1kW |

| Fuel effect | Control type | Model Number |
|-------------|--------------|--------------|
| Coal | Manual | GCMC00MN |
| | Slide | GCMC00SN |

Safety: Flame Supervision Device & Oxygen Depletion Sensor
Air vent required: Not normally

Dimensions

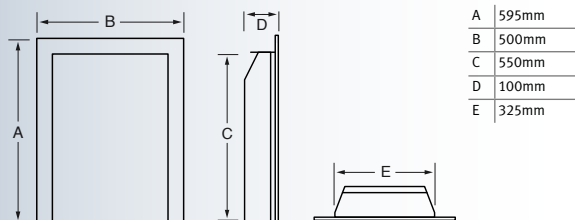

Dimensions A & B refer to Profiled trim only.



Corda with Profiled brass trim and Blenheim brass fret

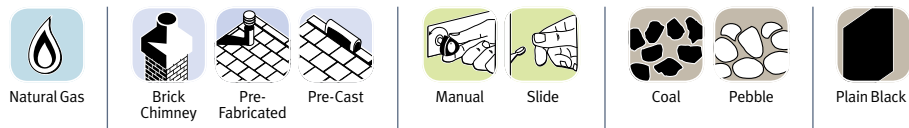

Karara

The Karara gives the appearance of a full depth fuel bed on a slimline gas fire. Designed for easy installation in to any chimney or flue, including pre-cast (BS EN 1858), this stylish fire is both versatile and affordable.

This fire comes complete with a plain brass effect or brushed silver trim. There is a choice of frets and alternative trim options on page 24.

Specifications

Description: Slimline inset gas fire
Type of Heat: Radiant

| | |
|--------------------|-------------|
| Direct Heat Output | 2.7kW |
| Fuel type | Natural gas |

| Fuel effect | Control type | Model Number | Trim |
|-------------|--------------|--------------|----------------|
| Coal | Manual | GSRC10MN | Brass |
| Coal | Manual | GSRC30MN | Brushed Silver |
| Pebble | Manual | GSRP30MN | Brushed Silver |

Safety: Flame Supervision Device & Oxygen Depletion Sensor
Air vent required: Not normally
This product is not suitable for primary heating purposes

Dimensions

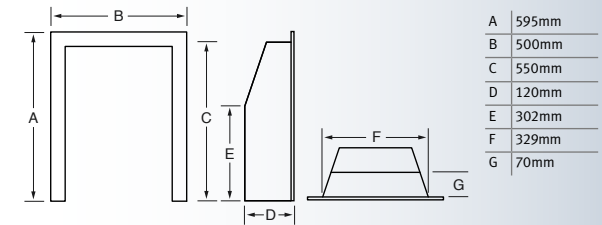

Dimensions A & B refer to Profiled trim only.



Karara with pebble effect fuel bed, brushed silver trim and Aegis silver fret



Karara with coals, brass effect trim and Blenheim brass fret



Natural Gas



Brick Chimney



Pre-Fabricated



Pre-Cast



Manual



Coal



Pebble



Plain Black

Delta

With an output of 2.7kW the Delta exudes a welcoming heat which is complemented by its full depth full bed and beautifully realistic dancing flame effect.

The Delta features a striking polished steel fascia with a choice of manual, slide or remote control, and a coal fuel bed. An optional pebble fuel effect is available at an additional cost.

In addition, this market leading radiant will fit almost any chimney or flue, including pre-cast (BS EN 1858) when fitted with a 3"/75mm rebated surround.

Specifications

Description: Full depth inset gas fire
Type of Heat: Radiant

| | |
|--------------------|-------------|
| Direct Heat Output | 2.7kW |
| Fuel type | Natural gas |

| Fuel effect | Control type | Model Number |
|-------------|--------------|--------------|
| Coal | Manual | GRDC34MN |
| | Remote | GRDC34RN2 |

Safety: Flame Supervision Device & Oxygen Depletion Sensor
Air vent required: Not normally
This product is not suitable for primary heating purposes

Dimensions

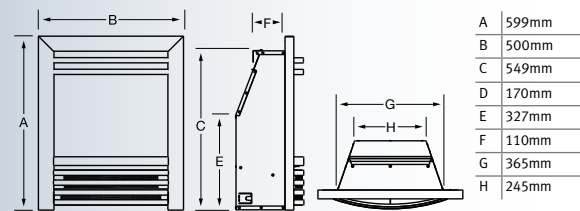

Dimensions A & B refer to Profiled trim only.



Delta with pebble fuel bed

Delta with coal effect fuel bed

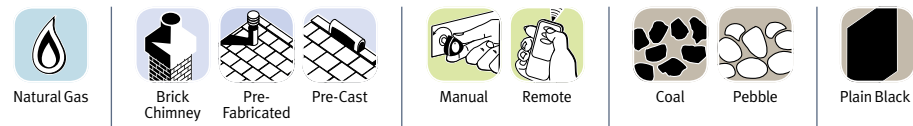

Natural Gas

Brick Chimney

Pre-Fabricated

Pre-Cast

Manual

Remote

Coal

Pebble

Plain Black

Hearth Inset – Open Fronted



Fantasy

The Fantasy features an outstanding coal or pebble fuel effect and beautiful flame picture. This open-fronted fire provides a maximum heat output of 2.7kW and can be installed into most chimney or flues, including precast (BS EN 1858) when fitted with a 3"/75mm rebated surround.

We also offer a Powerflue model for homes without a flue*. Customise the Fantasy with our extensive range of trims, frets and fascias (see pages 24 & 25). A pebble fuel effect is available as an optional extra.

Specifications

Description: Full depth inset gas fire
Type of Heat: Radiant

Conventional

| | | |
|--------------------|--------------|--------------|
| Direct Heat Output | 2.7kW | |
| Fuel type | Natural gas | |
| Fuel effect | Control type | Model Number |
| Coal | Manual | GRDC00MN |
| Coal | Slide | GRDC00SN |
| Coal | Remote | GRDC00RN2 |

This product is not suitable for primary heating purposes

Powerflue

| | | |
|--------------------------|--------------|--------------|
| Useful energy efficiency | 57.2% | |
| Energy efficiency class | F | |
| Fuel type | Natural gas | |
| Direct heat output | 3.6kW | |
| Fuel effect | Control type | Model Number |
| Coal | Manual | GVP00MN |

Safety: Flame Supervision Device & Oxygen Depletion Sensor
Air vent required: Not normally

Dimensions

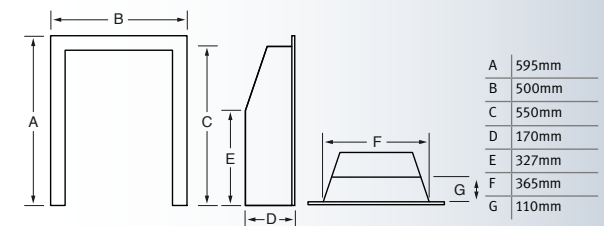

Dimensions A & B refer to Profiled trim only. Refer to page 26 for Powerflue dimensions.



Fantasy Coal with Profiled silver trim and Bauhaus silver fret

Fantasy Pebble with Deluxe Contemporary silver fascia



Natural Gas



Brick Chimney



Pre-Fabricated



Pre-Cast



Powerflue



Manual



Slide



Remote



Coal



Pebble



Plain Black

*A mains electric supply is required to power the fan unit.

†Not available on Fantasy powerflue models.

Trim options

Designer



BRASS BLACK/BRASS BRASS/BLACK SILVER BLACK/SILVER SILVER/BLACK
 Made from extruded anodised aluminium, Designer trims create fabulous dual combinations suitable for the Fantasy HE, Fantasy Plus, Arana Plus, Corda Plus, Arana, Corda, and Fantasy fires.

Profiled



BRASS PLATED BRUSHED SILVER PLATED POLISHED SILVER PLATED BLACK PAINTED
 The Profiled trim is made from steel and is available in brass, black and silver finishes. Suitable for all Global hearth inset gas fires.

Curved



BRASS SILVER BLACK
 The Curved trim is made from a high quality extruded aluminium and is available in anodised brass, anodised silver and black painted finishes. Suitable for Saranda HE*, Karara HE*, Fantasy HE*, Fantasy Plus*, Arana Plus*, Corda Plus, Fantasy*, Arana* and Fantasy Balanced Flue.

Ultimo



GOLD PLATED SILVER PLATED BLACK NICKEL PLATED
 The Ultimo is a cast iron trim with a black painted and optional colour plated finish. Suitable for Passion HE, Saranda HE, Fantasy HE, Karara HE, Arana Plus**, Fantasy Plus**, Corda Plus**, Arana, Corda, Karara and Fantasy.

Fret options

Bauhaus 18"



BLACK NICKEL PLATED GOLD PLATED POLISHED SILVER BLACK PAINTED

Bauhaus 151 18"



BLACK NICKEL PLATED



GOLD PLATED



SILVER PLATED

Blenheim 16"



ANTIQUE BRASS SOLID BRASS ANTIQUE SILVER BLACK PAINTED

Elegance 16"



SOLID BRASS BLACK & CHROME BLACK PAINTED

Balmoral 16"



SOLID BRASS BLACK PAINTED

Aegis 18"



SOLID BRASS POLISHED SILVER BLACK PAINTED

Grace 16"



SOLID BRASS POLISHED SILVER

Fascia options

Delta

The Delta is a one-piece fabricated steel fascia.

HEARTH INSET



POLISHED SILVER



BRUSHED SILVER



BRASS PLATED



BLACK PAINTED

Suitable for Delta HE, Saranda HE, Karara HE, Fantasy HE, Fantasy Plus, Arana Plus, Corda Plus, Arana, Fantasy BF and Fantasy.

WALL INSET



POLISHED SILVER

Suitable for Delta HE, Saranda HE*, Fantasy HE*, Karara HE*, Arana Plus*, Fantasy Plus*, Corda Plus, Fantasy*†, Arana* and Fantasy Balanced Flue.

Contemporary



POLISHED SILVER



BRUSHED SILVER

The Contemporary is a one-piece fabricated steel fascia. Not available with slide control, EFC, Arana Plus or any balanced flue models.

Deluxe Contemporary



ANTIQUE BRASS



SATIN BRASS



BRUSHED SILVER



BLACK PAINTED

The Deluxe Contemporary is a one-piece contemporary fabricated steel fascia that is available in antique brass, satin brass, brushed silver and black painted. This fascia is suitable for the Passion HE, Saranda HE*, Karara HE*, Fantasy HE*, Fantasy Plus*, Arana Plus*, Corda Plus, Corda*, Karara, and Fantasy*.

Arcadia



GOLD PLATED



SILVER PLATED

The Arcadia is a one-piece cast iron fascia in a combination of black painted with optional colour plated finish. Suitable for Saranda HE, Karara HE Fantasy HE, Fantasy Plus**, Arana Plus**, Corda Plus**, Arana, Fantasy BF**, Corda, Karara and Fantasy.

Embrace



GOLD PLATED



SILVER PLATED



BLACK NICKEL PLATED

The Embrace fascia is a one piece cast iron fascia in a combination of black painted and optional colour plated finish. Suitable for Saranda HE, Karara HE, Fantasy HE, Fantasy Plus**, Arana Plus**, Corda Plus**, Arana, Fantasy BF**, Corda, Karara and Fantasy.

Global Powerflue Fires



A gas fire creates a welcoming heart to any living room but many newer homes are being built without a chimney or flue so a conventional gas fire is not an option.

However, powerflue (PF) gas fires have been specifically designed for homes without a conventional flue system providing a gas fuelled alternative heat source to an electric fire or radiator.

The Fantasy Powerflue fire is flued from the rear of the fire and is suitable to be installed on a maximum flue length of 5 metres and 3 bends.



The Global Slimline Fan System fully recessed into an outside wall leaving only a discreet 3" projection. 96mm and 183mm spacers are available if required.

Powerflue Installation Possibilities

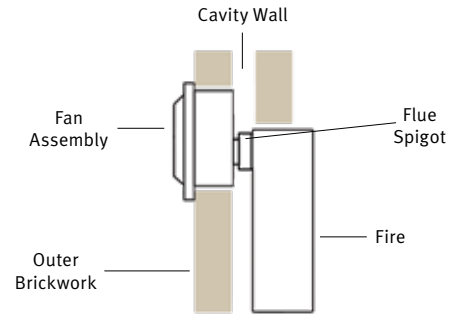

Example of powerflue installation

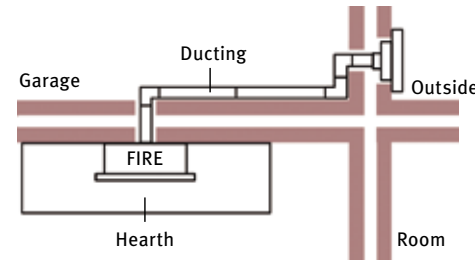

An example of a powerflue installation using three bends.

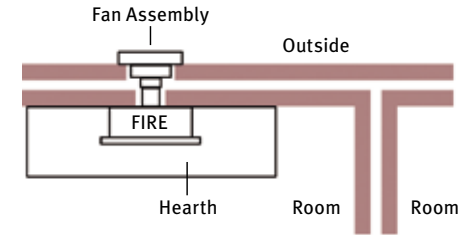

An example of a standard powerflue installation. The gas fire is flued directly through an outside wall via a straight, horizontal length of flue.

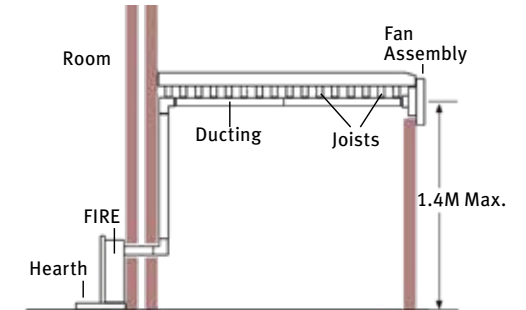

An example of a powerflue installation using a vertical section of flue pipe and two bends.

Fantasy Powerflue Dimensions

Please note, if required, more detailed information regarding technical specification is available from your Global stockist.

Fantasy MC PF



Fantasy Coal see page 23

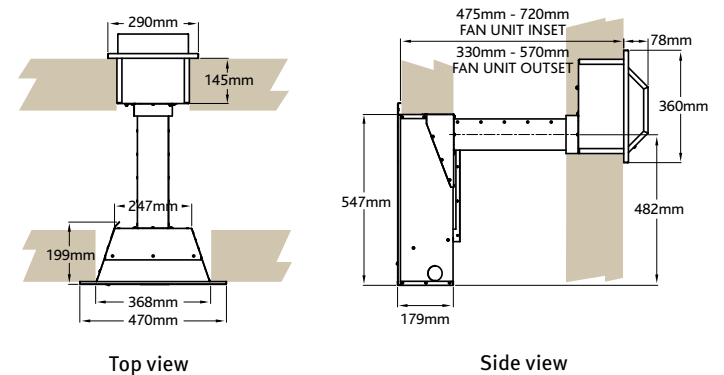

Online inspiration & information

Tap into a wealth of knowledge and discover everything you need to know about purchasing, fitting & servicing your Global fire.

- Use our intelligent search tools to find your perfect gas fire
- Find your nearest approved Global stockist
- Download installation and user manuals
- Register your guarantee
- Interactive updated blogs to keep you informed and intrigued

www.globalgasfires.co.uk





Watch the video

WWW.GLOBALFIRES.CO.UK

Go direct to the Global website on your smart phone or tablet device, just scan in this QR code.



WARNING BFM Europe Limited is a Gas Safe Register company. We recommend that all of our fires are installed by Gas Safe Register engineers in accordance with our instructions. DISCLAIMER Our policy is one of constant development and improvement. We therefore reserve the right to revise designs and specifications of our products without formal notice, patents pending. We always recommend our products be viewed in an approved showroom before purchase. Whilst we have taken every care in the preparation of this brochure it is not intended to replace the installation manual which provides more detailed information. Photography is for illustration purposes only and although every effort has been made to ensure accurate reproduction of typical installations and flame pictures they may vary according to fire model and flue types. We accept no liability for any loss or damage arising directly or indirectly from the use of this brochure. We recommend that all our fires are used in conjunction with central heating and not as a primary source of heat. In the interests of personal safety a suitable fireguard is recommended when children, the elderly and the infirm are present. (This brochure is copyright 2018 and must not be reproduced in whole or in any part without prior written permission).



BFM Europe Ltd, Gordon Banks Drive, Trentham Lakes, Stoke-on-Trent ST4 4TJ
Tel: 01782 339000 www.globalfires.co.uk Email: sales@bfm-europe.com