

GAZCO

Fire Your Imagination



Gas and Electric Stoves





A Warm Welcome

Nothing creates an inviting atmosphere quite like a Gazco stove. The centrepiece of any home, it will add warmth and character to any room or living space – even if you don't have a chimney! Whether you want to achieve a minimalist, contemporary look, or have your heart set on a more traditional stove, this brochure will help you make the perfect choice, whatever your interior tastes.

From the highly efficient contemporary Gas Loft range with all its style and elegance, to the stunning cast iron detail on traditional Huntingdon stoves, these innovative designs will appeal to any modern or traditional home.

There is also a range of highly realistic, electric log-effect stoves featuring either Gazco's Chromalight® or VeriFlame™ technology. These electric versions open up new possibilities such as conservatories, kitchens, dining rooms and bedrooms for you to have the warmth and character of a Gazco stove in your home.





Contents

Relax – it's a Gazco stove	6
Flue and Fuel Types	8 - 9
Traditional Styles	
Gas and Electric Marlborough2	10 - 13
Gas and Electric Stockton & Stockton2	14 - 19
Gas and Electric Huntingdon	20 - 27
Contemporary Styles	
Gas Loft	28 - 29
Gas Loft Steel Styling Options	30 - 31
Gas Loft Stone Base Options	32 - 33
Gas Loft Wall Mounted	34 - 35
Gas Vogue Midi	36 - 37
Gas Vogue Midi T	38 - 39
Gas Vogue Midi T Wall Mounted	40 - 41
Electric Vogue	42 - 43
Gas Vision	44 - 51
Electric Vision	52 - 53
Gas Riva2 F670 Glass	54 - 55
Gas Riva2 F670 Steel	56 - 57
Studio Freestanding Gas	58 - 61
Additional Information	62 - 63
Stove Selector	64 - 65
Technical Information	66 - 77
Balanced Flue Stove Systems	78
Stove Benches	79



Relax – it's a Gazco stove

When you choose Gazco, quality and innovative technology are assured. From traditional models to contemporary designs, Gazco is committed to creating the ultimate flame-effect gas and electric stoves.

Our research and development laboratories are amongst the most advanced in the world, ensuring that the very latest innovations are incorporated into our appliances.

Gazco is an ISO9001 and ISO14001 accredited company. Our rigorous quality control system ensures that all our appliances are safety checked and that they comply with the appropriate regulations, with all stoves in this brochure bearing the CE mark. Similarly, our environmental management systems ensure we work in a sustainable manner, whilst endeavouring to protect the environment by minimising any possible impact from our operations.



Warranty

Your Gazco Expert Retailer will provide you with a Two Year Warranty for your new gas or electric stove. The warranty for gas stoves can be extended to a period of five years by registering your stove with Gazco. Please note, these warranties exclude certain consumable parts. Stoves purchased outside of Gazco's Expert Retailer Network will carry a standard One Year non-extendable Warranty. Full warranty terms & conditions are available to view at www.gazco.com.



Selecting Your Stove

Before you choose your new stove you will need to know what type of chimney (if you have one) or flue you have. Please turn to pages 8 - 9 to identify your chimney or flue type.

Expert Retailer Network

We take great care to ensure that our stoves are designed, tested and manufactured to the highest possible quality and safety standards. We are just as concerned to make certain that they are sold and installed correctly so that you enjoy years of pleasure from your purchase.

Accordingly, you will find our products are only available from experienced, independent retailers who will be happy to show you a selection of models locally in their showrooms, often fully operational. These independent retailers will discuss your individual requirements both technical (such as sizing the heat output to your room and advising on your flue type) and design, and ensure that you select the most appropriate product for your home. These retailers will also be able to advise on, or assist with, the installation process as well as help provide any after-sales support and servicing your appliance may require in the future.

Whilst we encourage our retailers to promote fireplace products and their outlets via the internet, we do not believe suitable levels of customer care and satisfaction can be obtained from purchasing the product only online and we would strongly recommend that you consider this when undertaking your research and making a purchasing decision. Furthermore, please be aware that we do not offer technical support (beyond our statutory responsibilities) to products bought via nationwide online sales, where this support would normally be offered by one of our qualified, independent retailers.

Furthermore, Gazco fires and stoves purchased from within our Expert Retailer Network will have the additional benefit of a greatly extended warranty period, subject to terms and conditions. Full details can be found at www.gazco.com.

Find Your Retailer

You can find your nearest retailer by visiting www.gazco.com/find-a-retailer





What's your type?

Before you select your stove, your local Gazco retailer will need to make sure it's suitable for your home. Firstly, you need to know what fuel type you will be using. Secondly, you will need to be aware of what type of chimney or flue you have. If you do not have a chimney then don't worry, Gazco have models developed to suit your home too! To assist you in selecting the right stove for your home, a general guide to which models can be installed with the various flue types is given on each page.

Fuel - Gas or Electric?

The majority of our stoves are available in either gas or electric versions. All the electric models run on a standard 13amp plug and have no need for a chimney.

Which Gas type....

All Gazco gas stoves in this brochure can be specified for use with either Natural Gas or LPG. Natural Gas is provided through mains pipelines, whilst LPG is usually supplied to homes in rural areas from a tank in the garden or gas bottles.

Your Home...

The type of chimney or flue you have usually dictates your choice of stove. To help you understand which stoves are suitable for your home, please use the information and pictures shown opposite to identify your chimney. Don't worry, if you don't have a chimney though, you can still find the perfect stove for your home. Once you have identified your chimney(or confirmed you do not have one), take note of the symbol that represents this, as this has been used throughout the brochure to represent the stoves that are suitable for installation in your home.

Conventional Flue

Conventional flue systems are easily recognisable as either a conventional brick or stone chimney, pre-fabricated or precast chimney system. Should your home have none of these at present, it is usually possible to have a pre-fabricated system installed in your home if required.



Brick or Stone Chimney
(Class 1) **1**

The chimney stack rises well above the roofline and is topped by a traditional chimney pot or gas terminal. This type of chimney relies on the natural circulation of heated air to expel the products of combustion up your chimney.



Pre-Fabricated Flues
(Class 1 & 2) **2**

You will see a metal flue cowl on your roof. Some are all metal whilst others may terminate through a short rectangular pot (but without a chimney stack). These flues create the same circulation of heated air as a brick or stone chimney.

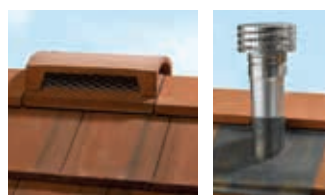

Pre-Cast flues
(Class 2) **3**

Many modern homes have been built with such flues. You can readily identify them by either a metal flue cowl or a raised ridge terminal on your roof. Again, the natural circulation of heated air expels the products of combustion. This option is only available on the small stoves.

Balanced Flue

Balanced flues work in conjunction with Gazco's Glass Fronted gas stoves. The appliance is completely sealed from the room into which it is installed (so there are no draughts and heating efficiency is increased) and a twin-wall pipe vents directly to an outside wall.



Balanced Flue
(No chimney required) **BF**



Air for combustion is drawn in through the outer pipe whilst the inner pipe removes the combustion gases to the exterior of the property. Depending on the stove selected, the twin-walled pipe may exit horizontally through an external wall or vertically through the roof. Gazco offers a comprehensive range of balanced flue system components. Please refer to our dedicated Concentric Flue System brochure which can be requested from your retailer or viewed online at www.gazco.com.



Electric Stoves
(No chimney required) **⚡**

Gazco produce an excellent selection of electric Marlborough2, Stockton, Huntingdon, Steel Manhattan and Vision stoves which do not require a chimney or flue of any kind.

No Air Vent required (UK) **⊗**

All stoves shown with this symbol, boast the advantage of not normally requiring an air vent* where the air permeability is greater than 5.0m³/hr/m². Please discuss this in full with your local Gazco retailer.

*Requirements in the Republic Of Ireland are different.



Gas Marlborough2



Medium Gas Marlborough2 balanced flue



Small Gas Marlborough2 conventional flue

Country or city, traditional or contemporary, the innovative Gas Marlborough2 has the flexibility to suit your lifestyle and your décor. Available in two sizes, each has an expansive window area to allow you to enjoy the dancing flames and warm ambience of the log-effect fire.

Operation is simple thanks to the easy ignition and manual control which lets you adjust flame height and heat output. Choose Gazco's Command upgradeable remote control and you can adjust the flames and heat from your armchair. Alternatively, opt for the Programmable upgradeable remote control to set the stove to switch itself on and off and heat the room to the temperature you select.

Heat Output

S: 1.30 - 2.50kW 

M: 2.78 - 5.40kW 

Fuel Bed

Logs

Efficiency

S: Conventional flue: 76%

S: Balanced flue: 85.1%

M: Conventional flue: 78%

M: Balanced flue: 90.8%

Energy Efficiency Class

S: Conventional flue: E

S: Balanced flue: C*

M: Conventional flue: E

M: Balanced flue: B*

Command Controls

Manual

Standard upgradeable

Programmable Thermostatic upgradeable

Chimney Types

(please see pages 8-9)

* When using Programmable Thermostatic Remote

Efficiency figures given are based upon the maximum heat output achieved for these models.

For complete model choices, specifications and additional information please see page 62 onwards.

Electric Marlborough2



Featuring the same distinctive styling as the Gas Marlborough2 shown on the preceding pages, the two electric versions offer you an amazingly realistic log-effect fire at the touch of a button. At its heart is Gazco's unique VeriFlame™ technology which allows you to choose from two heat settings that can both be thermostatically controlled; three flame brightness levels, plus the additional option for a blue flame effect on the high setting. Furthermore, the flame effect can be displayed without heat, allowing you to enjoy your fire all year round.

The Electric Marlborough2 stoves simply plug into a 13amp socket, so are particularly suited for conservatories, bedrooms or home studies, in fact any room without a chimney.

* The thermostat is controlled manually from the stove.

Heat Output

S: 1.00 - 2.00kW

M: 1.00 - 2.00kW

Fuel Bed

Logs

Command Controls

Remote as standard

Chimney Types

No chimney required

Efficiency figures given are based upon the maximum heat output achieved for these models.

For complete model choices, specifications and additional information please see pages 60- 61 and 65-66

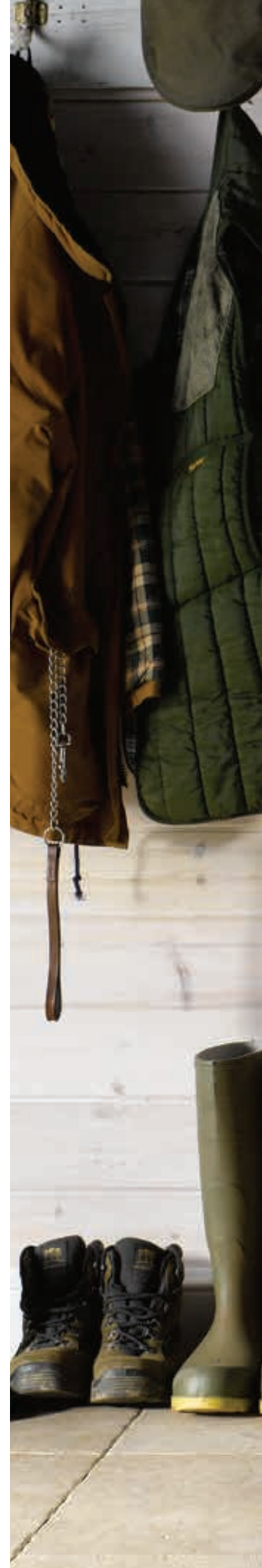





Gas Stockton2



Using cast iron for the door and heavy gauge steel for the body, Gas Stockton2 stoves combine simple, understated lines with Gazco's superb living flame technology.

Both Small and Medium sizes provide superior flames, with carefully positioned flame ports ensuring a varied and natural display amongst the hand painted logs.

Stockton2 stoves can be upgraded with either a Standard or Programmable Thermostatic remote control if desired, and are available in either conventional or balanced flue versions to suit a variety of installations.

Heat Output

S: 1.30 - 2.50kW 

M: 2.78 - 5.40kW 

Fuel Bed

Logs

Efficiency

S: Conventional flue: 76%

S: Balanced flue: 85.1%

M: Conventional flue: 78%

M: Balanced flue: 90.8%

Energy Efficiency Class

S: Conventional flue: E

S: Balanced flue: C*

M: Conventional flue: E

M: Balanced flue: B*

Command Controls

Manual

Standard upgradeable

Programmable Thermostatic upgradeable

Chimney Types

(please see pages 8-9)

See additional image on page 62.

* When using Programmable Thermostatic Remote

Efficiency figures given are based upon the maximum heat output achieved for these models.

For complete model choices, specifications and additional information please see page 62 onwards.



Gas Stockton 5



With authentic multi-fuel stove styling, right down to the hinged door with handle, the Gas Stockton 5 is conveniently sized between the small and medium models featured on the previous page. So you have even more opportunity to suit your needs – and to enjoy all the enchantment of a real coal or log-effect fire.

Please see page 66 for additional image.

Heat Output

2.40 - 3.50kW 

Fuel Bed

Logs
Coals

Efficiency

Conventional flue: 73%
Balanced flue: 91.8%

Energy Efficiency Class

Conventional flue: E
Balanced flue: B[†]

Command Controls

Manual
Standard upgradeable
Programmable Thermostatic upgradeable

Chimney Types

1 **2** **BF**

(please see pages 8-9)

[†] When using Programmable Thermostatic Remote

*Please note this is a viable installation in stone, but not suitable for combustible materials.

Efficiency figures given are based upon the maximum heat output achieved for these models.

For complete model choices, specifications and additional information please see page 62 onwards.

Electric Stockton



Electric Stockton2 Medium in Matt Black



Electric Stockton2 Small in Matt Black

Using the same cast iron door and heavy gauge steel body as the Gas Stockton2, the electric version combines the classic looks of a woodburning stove with the ease of Gazco's unique VeriFlame™ technology. This means you can enjoy two heat settings that can both be thermostatically controlled; three flame intensity levels, plus the additional option for a blue flame effect on the high setting to create a remarkably authentic log-effect fire - a superb focal point for any room. Choose from the Stockton2 Small, Stockton 5 or the Stockton2 Medium.

Colour

Matt Black

Fuel Bed

Logs

Heat Output

Stockton2 Small: 1.00 - 2.00kW

Stockton 5: 1.00 - 2.00kW

Stockton2 Medium: 1.00 - 2.00kW

Command Controls

Remote as standard

Chimney Types



No chimney required

Efficiency figures given are based upon the maximum heat output achieved for these models.

For complete model choices, specifications and additional information please see page 62 onwards.

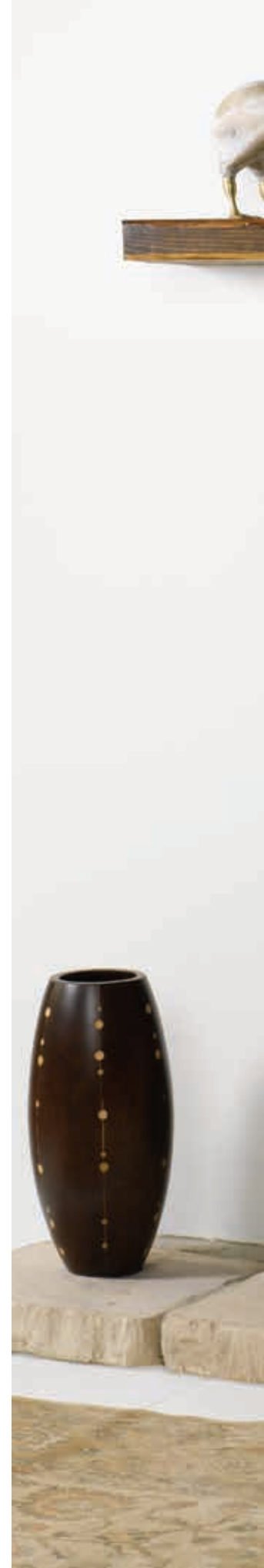





Gas Huntingdon 20



Gas Huntingdon 20 with Tracery Door in Matt Black, shown with Belgravia polished cast front from Stovax.

The compact Gas Huntingdon 20's proportions make it perfect for British fireplace openings, whilst its highly efficient 2.5kW heat output easily creates a warming atmosphere in standard sized rooms. Producing dancing flames over a realistic log fuel bed, this stove is offered with Standard and Programmable Thermostatic remote controls, providing real fire ambience at the touch of a button.

Presented in either Matt Black, Matt Ivory or Ivory enamel finishes, the Huntingdon 20 lets you choose a colour that best suits your home. Further expanding the styling options available, this elegant stove is also offered in both clear door and tracery versions.

Also see image on page 69.

Colour Choice

Matt Black
Matt Ivory
Ivory

Heat Output

1.30 - 2.50kW 

Fuel Bed

Logs

Efficiency

Conventional flue: 76%
Balanced flue: 85.1%

Energy Efficiency Class

Conventional flue: E
Balanced flue: C*

Command Controls

Manual
Standard upgradeable
Programmable Thermostatic upgradeable

Chimney Types

(please see pages 8-9)

* When using Programmable Thermostatic Remote

Efficiency figures given are based upon the maximum heat output achieved for these models.

For complete model choices, specifications and additional information please see page 62 onwards.



Gas Huntingdon 30



Gas Huntingdon 30 conventional flue with tracery door and coal-effect in Matt Black



Gas Huntingdon 30 with clear door and log-effect in Ivory enamel

The Gas Huntingdon 30 combines refined styling with efficient heating technology. Available in Matt Black, Matt Ivory and Ivory enamel finishes, the beautiful flame picture gives great warmth and style to any interior. The Huntingdon 30 is available with either elegant tracery or as a clear door version for stylistic versatility.

Choose from either realistic coal or log fuel effects, the latter sporting a glowing ember bed for the ultimate real fire ambiance. Both fuel effects are available in conventional flue versions, whilst the log effect is also available in a balanced flue model. The Gas Huntingdon comes with manual control or, for total ease and convenience, upgrade to one of Gazco's command remote controls.

Also see image on rear cover.

Colour Choice

Matt Black
Matt Ivory
Ivory

Fuel Bed

Logs
Coals

Heat Output

2.10 - 3.70kW 

Efficiency

Conventional flue: 75%
Balanced flue: 95.4%

Energy Efficiency Class

Conventional flue: E
Balanced flue: A*

Command Controls

Manual
Standard upgradeable
Programmable Thermostatic upgradeable

Chimney Types

1 **2** **BF**

(please see pages 8-9)

* When using Programmable Thermostatic Remote

Efficiency figures given are based upon the maximum heat output achieved for these models.

For complete model choices, specifications and additional information please see page 62 onwards.



Gas Huntingdon 40



Gas Huntingdon 40 with tracery door in Matt Ivory.
Shown with Sandringham Limestone Mantel

The largest model in the Huntingdon range, the Gas Huntingdon 40 is perfectly at home in big open fireplaces or spacious interiors. With a powerful heat output of 5.4kW, it can quickly create a warming atmosphere whilst still maintaining an exceptional efficiency up to 90.8%, thanks to its cutting edge gas stove technology.

Presented in a three finishes; Matt Black, Matt Ivory and Ivory enamel, the Huntingdon 40 can be chosen with a tracery door for refined style or clear door for an uninterrupted view of the realistic log bed and rolling flames, allowing you to select the styling that fits your décor.

For added convenience, the Huntingdon 40 can be upgraded from manual operation with a choice of optional handsets for remote control as well as programmable thermostatic and timer functionality.

Also see image on page 4.

Colour Choice

Matt Black
Matt Ivory
Ivory

Heat Output

2.78 - 5.40kW 

Fuel Bed

Logs

Efficiency

Conventional flue: 78%
Balanced flue: 90.8*%

Energy Efficiency Class

Conventional flue: E
Balanced flue: B*

Command Controls

Manual
Standard upgradeable
Programmable Thermostatic
upgradeable

Chimney Types

1 **2** **BF**

(please see pages 8-9)

* When using Programmable Thermostatic Remote

Efficiency figures given are based upon the maximum heat output achieved for these models.

For complete model choices, specifications and additional information please see page 62 onwards.

Electric Huntingdon



Electric Huntingdon 30 in Matt Ivory



Electric Huntingdon 20
with tracery door in Matt Black

The fine castings of the Huntingdon Electric range are brought alive with Gazco's VeriFlame™ technology, which gives you two heat settings that can both be thermostatically controlled. In addition, there are also three flame brightness levels to choose from as well as the option of a blue flame effect on the highest heat setting.

Your choice of flame effect is set against the highly realistic fuel bed and individually hand painted logs, perfectly mirroring the look and atmosphere of a real woodburning stove.

The Huntingdon Electric range is available in a number of finishes to complement your home. For even more styling options, each size is also offered in either clear door or tracery door versions.

* The thermostat is controlled manually from the stove.

Colour Choice

Matt Black
Matt Ivory
Ivory

Heat Output

Huntingdon 20: 1.0 - 2.0kW
Huntingdon 30: 1.0 - 2.0kW
Huntingdon 40: 1.0 - 2.0kW

Fuel Bed

Logs

Command Controls

Remote as standard

Chimney Types



No chimney required

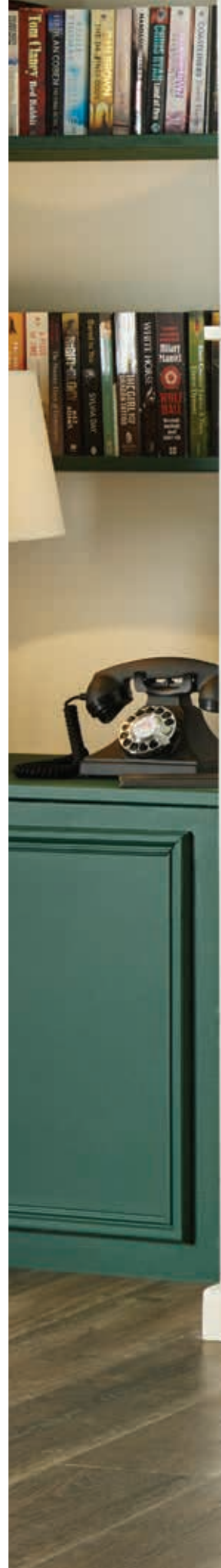

Efficiency figures given are based upon the maximum heat output achieved for these models.



loft

gas stove range

Clear-cut lines and sleek surfaces ensure the Loft's pure design creates a striking focal point in your interior.

Reflective black glass frames the stove's tall firebox, subtly contrasting with the matt steel body. Soaring flames dance amongst a highly realistic fuel bed, composed of hand painted logs. Visuals are mirrored on all sides by the EchoFlame™ Black glass lining - a continuation of the stove's glossy exterior styling details.

This premium gas stove is available in either conventional or balanced flue models and provides up to a 4.8kW heat output, which can be effortlessly controlled with the fully sequential Programmable Thermostatic remote control.





Luxurious styling possibilities

Loft stoves can be styled with a variety of accessories, including a choice of luxury stone mounting options. Choose from cleanly styled Plinth and Logstore bases, with either option offered in matching steel, as well as smart Castillo grey sandstone (page 32) or luxurious Woodgrain sandstone (pages 33 & 73).

This versatile stove is also available as a wall mounted version, for an ultra-modern floating installation that lends itself perfectly to contemporary settings.

Regardless of the mounting options selected, this tall stove's height can be accentuated with a striking matching steel top section (see pages 2 and 30), hiding the flue pipe and continuing the stove's clean lines.

E C H O F L O M E TM
BLACK GLASS LINING

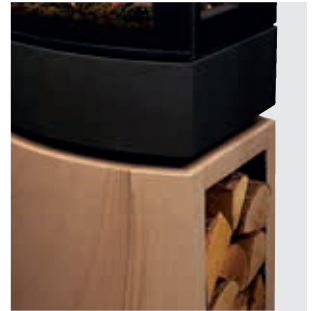

Loft

Loft with Steel Plinth

Loft with Steel Log Store Base

Loft with Steel Log Store Base and Top Section

Loft with Optional Wall Mounting Bracket

Loft with Optional Wall Mounting Bracket and Top Section

view the video



To experience the Loft range's superb flame visuals and contemporary styling, view our short video at www.gazco.com/loft





2
3
4

Gas Loft - Steel Styling Options



Loft with Steel Log Store

The Loft can be tailored to your home with a host of styling options including Plinth and Logstore bases in matching matt black steel. A tall hood can also be added to accentuate the stove's height. For more information on the full range, see preceding pages.

Please see pages 2 and 28 for additional images.

Heat Output

2.90 - 4.50kW 

Fuel Bed

Logs

Chimney Types

1 **2** **BF**

(please see pages 8-9)

Efficiency

Conventional Flue: 78%

Balanced Flue: 94.3%

Energy Efficiency Class

Conventional Flue: D

Balanced Flue: A

Command Controls

Programmable

Thermostatic remote

ECHOFLAME™
BLACK GLASS LINING

Efficiency figures given are based upon the maximum heat output achieved for these models. For complete model choices, specifications and additional information please see page 62 onwards. For Bench options please see page 79.



Gas Loft- Stone Base Options



Loft with Woodgrain Sandstone Plinth

The Loft's Plinth and Midline base options are also available in two elegant sandstones. Choose from either smart Castillo sandstone, with its subtle vertical striations or the warm Woodgrain sandstone with its deep, flowing seams. Each stone Plinth and Midline base is cut from natural sandstone for a beautifully unique appearance.

Please see page 73 for additional image.

Heat Output

2.90 - 4.50kW 

Fuel Bed

Logs

Chimney Types

1 **2** **BF**

(please see pages 8-9)

Efficiency

Conventional Flue: 78%

Balanced Flue: 94.3%

Energy Efficiency Class

Conventional Flue: D

Balanced Flue: A

Command Controls

Programmable

Thermostatic remote

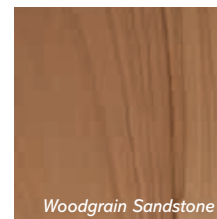

Woodgrain Sandstone



Castillo Sandstone

ECHOFLAME™
BLACK GLASS LINING

Efficiency figures given are based upon the maximum heat output achieved for these models.

For complete model choices, specifications and additional information please see page 62 onwards.

For Bench options please see page 79.

Gas Loft Wall Mounted



Loft with optional Wall Mounting Bracket

The balanced flue Loft can be mounted on the wall to achieve an alternative, 'floating' installation, which can be styled with the matching top section if required. Top or rear flue options offer further installation versatility.

Heat Output

2.90 - 4.50kW 

Fuel Bed

Logs

Chimney Types

BF

(please see pages 8-9)

Efficiency

Balanced Flue: 94.3%

Energy Efficiency Class

Balanced Flue: A

Command Controls

Programmable

Thermostatic remote

ECHOFLAME™
BLACK GLASS LINING

Efficiency figures given are based upon the maximum heat output achieved for these models.
For complete model choices, specifications and additional information please see page 62 onwards.

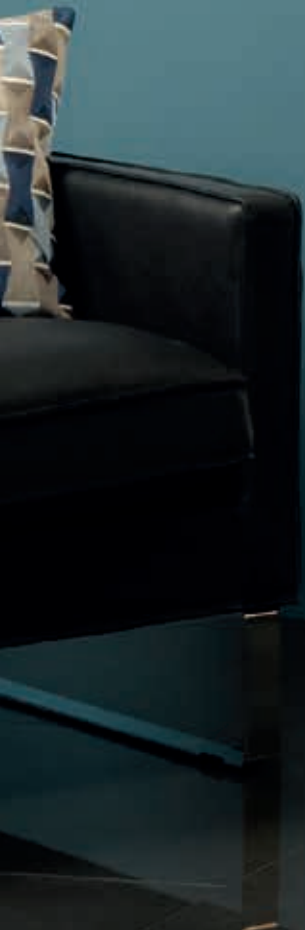

Gas Vogue Midi



Gas Vogue Midi Midline conventional flue

Elegantly styled to fit equally well in either contemporary or traditional settings alike, the Vogue Midi gas stoves feature a cast iron door and top plate with refined curves and bevelled edges. For increased presence, Midline models are mounted on a matching log store base that can be used to house chopped logs to add to the woodburning aesthetic.

Creating breathtaking flame visuals, Vogue Gas stoves feature a highly realistic log bed and a polished EchoFlame Black Glass lining that provides a stunning, multi-sided reflection of the flames. Designed with the very latest gas fire technology, these cutting edge stoves provide an ample 3.9kW of heat up to 90.6% efficiency.

For greater convenience, these stylish stoves can be upgraded with a Programmable Thermostatic handset which allows you to pre-set the stove to provide heat at selected times or temperatures.

Heat Output

1.80 - 3.90kW

Sizes Available

Midi
Midi Midline

Fuel Bed

Logs

Efficiency

Conventional Flue: 76%
Balanced Flue: 90.6%

Energy Efficiency Class

Conventional Flue: E
Balanced Flue: B*

Chimney Types

1 **2** **BF**

(please see pages 8-9)

Command Controls

Manual
Standard upgradeable
Programmable Thermostatic
upgradeable

ECHOFLAME™
BLACK GLASS LINING

* When using Programmable Thermostatic Remote

See additional image on page 72

Efficiency figures given are based upon the maximum heat output achieved for these models.
For complete model choices, specifications and additional information please see page 62 onwards.
For bench options please see page 79.





Gas Vogue Midi T



Gas Vogue Midi T Midline conventional flue



Gas Vogue Midi T conventional flue

The versatile Vogue Midi T gas stove range provides stunning flames and a high efficiency heat output of up to 94.3%. Taking the elegant styling of the smaller Midi range (pages 34 -35), the Midi T's bevelled cast iron exterior encases a taller firebox that offers a three-sided view of the impressive visuals.

Vogue Midi T stoves feature a highly realistic log-effect fuel bed which is reflected on multiple sides by Gazco's EchoFlame Black Glass interior. Each ceramic log is positioned to create varied and natural flames almost indistinguishable from a real woodburning fire.

This contemporary stove is also available in Midline (above & page 5) or Highline (left) versions, which feature stylish bases that can be filled with logs to add to the wood fire aesthetic. In addition, the Midi T balanced flue is also available as a wall mounted model (see overleaf).

Heat Output

2.00 - 4.80kW 

Sizes Available

Midi T
Midi T Midline (page 5)
Midi T Highline

Efficiency

Conventional Flue: 78%
Balanced Flue: 94.3%

Fuel Bed

Logs

Chimney Types

(please see pages 8-9)

Energy Efficiency Class

Conventional Flue: E
Balanced Flue: A*

Command Controls

Manual
Standard upgradeable
Programmable Thermostatic upgradeable

ECHOFLAME™
BLACK GLASS LINING

* When using Programmable Thermostatic Remote

Efficiency figures given are based upon the maximum heat output achieved for these models.
For complete model choices, specifications and additional information please see page 62 onwards.





Gas Vogue Midi T Wall Mounted



Gas Vogue Midi T Wall Mounted balanced flue

For an alternative installation to the standard and Midline versions, the Midi T Wall Mounted makes for a strikingly contemporary statement. This floating installation can be either rear or top flued depending on your preferences and is available as a balanced flue model only.

All Vogue Midi T models can be upgraded with a remote control allowing you to adjust the flames and heat without leaving your armchair. There is also the option of a Programmable Thermostatic handset, which allows you to preset your stove to turn on at specific times and temperatures.

Heat Output

2.90 - 4.80kW 

Fuel Bed

Logs

Efficiency

94.3%

Energy Efficiency Class

Balanced Flue: A*

Chimney Types

 BF

(please see pages 8-9)

Command Controls

Manual

Standard upgradeable

Programmable Thermostatic upgradeable

E C H O F L A M E™
BLACK GLASS LINING

* When using Programmable Thermostatic Remote

Efficiency figures given are based upon the maximum heat output achieved for these models.

For complete model choices, specifications and additional information please see page 62 onwards.



Electric Vogue Midi



Vogue Midi Midline Electric with Log & Pebble Fuel effects and Amber and Blue Accent flame setting

The Vogue Midi range represents the latest innovation in electric stove design, creating deep, captivating, 3D flame effects with incredible realism. Gazco's ChromaLight® Immersive LED technology lets you independently control flame and ember bed lighting effects to create the perfect ambience in virtually any part of the home.

The Vogue Midi is offered in two models including the taller Midline log store version (above), which can be stacked with logs to add to the authentic wood fire display. A choice of fuel beds come with both models including logs, pebbles & crystal-effects, with each stove letting you mix & match to create a bespoke display.

Gazco's Programmable Thermostatic Eco remote provides complete control over the stove's visuals as well as allowing you to schedule heating to suit your lifestyle. Innovative energy saving features ensure the Vogue Midi runs as efficiently as possible.

Colour

Matt Black

Interchangeable

Fuel Beds

Log & Pebble

Crystal Ice-effect (page 76)

Chimney Types



No chimney required

Heat Output

1.00 - 2.00kW

Flame Visual Settings

Amber

Blue

Amber with Blue Accent

Command Controls

Programmable Thermostatic

Eco remote control



Crystal Ice-effect (see page 67 for further image)

For complete model choices, specifications and additional information please see page 62 onwards.

For Bench options please see page 79





Gas Vision Small



The Gas Vision Small offers beautiful, contemporary aesthetics in a neat package – well suited to standard chimney openings thanks to its compact proportions.

Providing a highly efficient heat output of up to 2.50kW, this cutting edge gas stove is available in either conventional or balanced flue versions for flexible installation options.

The Vision Small comes with manual controls as standard, but can be upgraded with remote control options including a Programmable Thermostatic handset, allowing the stove to be preset to turn on at certain times or temperatures.

Finish

Black Glass

Heat Output

1.30 - 2.50kW 

Fuel Bed

Logs

Efficiency

Conventional flue 76%

Balanced flue 85.1%

Energy Efficiency Class

Conventional flue: E

Balanced flue: C*

Command Controls

Manual

Standard upgradeable

Programmable Thermostatic upgradeable

Chimney Types

(please see pages 8-9)

* When using Programmable Thermostatic Remote

Efficiency figures given are based upon the maximum heat output achieved for these models.

For complete model choices, specifications and additional information please see pages 62 onwards.

For Bench options please see page 79.



Gas Vision Midi



With its pure lines and stylish black glass surfaces, the Gas Vision Midi brings the age old concept of the stove into the present day, offering wood fire ambience with clean, modern styling. Featuring mesmerising rolling flames and a highly realistic log effect fuel bed, the Midi can generate up to 3.70kW of heat at a staggering 95.4% efficiency – making it a both stylish and practical heating solution.

For further styling options, all Visions can be installed on a Bench (see page 79), elevating the stove for added impact and presence.

Packed with state of the art technology, all Gas Vision stoves can be controlled with an optional Programmable Thermostatic remote, for easy and convenient control.

Finish

Black Glass

Fuel Bed

Logs

Heat Output

2.10 - 3.70kW 

Efficiency

Conventional flue: 75%

Balanced flue: 95.4%

Energy Efficiency Class

Conventional flue: E

Balanced flue: A*

Command Controls

Manual

Standard upgradeable

Programmable Thermostatic upgradeable

Chimney Types

1 **2** **BF**

(please see pages 8-9)

* When using Programmable Thermostatic Remote

Efficiency figures given are based upon the maximum heat output achieved for these models.

For complete model choices, specifications and additional information please see pages 62 onwards.

For Bench options please see page 79.



Gas Vision Medium



Gas Vision Medium

The Gas Vision Medium is one of the larger models in the range with a powerful heat output to match, making it a great choice for installing into expansive inglenook fireplaces or bigger rooms.

Enhancing the view of the fire, the Medium's firebox features mirrored stainless steel sides that reflect the rolling flames and allow them to be viewed from multiple angles.

Along with the other models in the Vision range, the Medium benefits from advanced gas fire technology, and can be upgraded with a remote control or alternatively a Programmable Thermostatic handset for increased functionality.

Finish

Black Glass

Fuel Bed

Logs

Heat Output

2.78 - 5.40kW 

Efficiency

Conventional flue: 78%

Balanced flue: 90.8%

Energy Efficiency Class

Conventional flue: E

Balanced flue: B*

Command Controls

Manual

Standard upgradeable

Programmable Thermostatic upgradeable

Chimney Types

(please see pages 8-9)

* When using Programmable Thermostatic Remote

Efficiency figures given are based upon the maximum heat output achieved for these models.

For complete model choices, specifications and additional information please see pages 62 onwards.

For Bench options please see page 79.

Gas Vision Large



Gas Vision Large balanced flue with Pebble & Stone fuel bed, EchoFlame Black Glass lining and Gloss Black flue pipe

With an arresting landscape presence and lustrous black glass surfaces, the Gas Vision Large makes a powerful design statement in any interior. Providing a captivating flame picture, this stylish stove features a choice of stunning fuel effects to enhance the visuals. Choose from Log-effect, Driftwood-effect or Pebble & Stone to create the perfect ambience for your home.

The Vision Large stove features Gazco's EchoFlame Black Glass lining, which creates a superb multi-sided reflection of the flames. In addition, Vermiculite and Black Reeded linings can also be selected as an optional extra. Available in both conventional and balanced flue versions, this versatile stove is suitable for a wide range of homes including those without a chimney.

Finish

Black Glass

Heat Output

3.00 - 5.30kW 

Efficiency

Conventional flue: 72%

Balanced flue: 92%

Chimney Types

1 2 BF

(please see pages 8-9)

Energy Efficiency Class

Conventional flue: E

Balanced flue: A*

Linings*

EchoFlame Black Glass (as standard)

Vermiculite (optional)

Black Reeded (optional)

*please see page 63 for lining details

Fuel Beds

Driftwood-effect

Pebble & Stone

Log-effect

Command Controls

Programmable

Thermostatic Remote

ECHOFLAME™
BLACK GLASS LINING

Please see page 79 for additional image.

Efficiency figures given are based upon the maximum heat output achieved for these models. For complete model choices, specifications and additional information please see page 62. For Bench options please see page 79.



Gas Vision Large conventional flue with Driftwood-effect fuel bed, EchoFlame Black Glass lining and Gloss Black flue pipe on a 140 Low Bench



Electric Vision



Electric Vision Medium

The Vision is a contemporary, electric stove that comes in three sizes: Small, Midi & Medium; each sporting a highly reflective black glass door, integral glass plinth, black glass top plate and stainless steel detailing for a clean stylish look.

Incorporating an eye-catching flame effect created using Gazco's unique VeriFlame™ technology, the Vision's alluring visuals glow over a realistic hand painted log-effect fuel bed to give all the ambiance and depth of a real log fire. To increase your interior design possibilities, you can enhance your Vision by choosing from one of ten stylish Stove Benches as shown on page 79.

Please see further image on page 79.

**The thermostat is controlled manually from the stove.*



Highly reflective stove lining

Finish

Black Glass

Fuel Bed

Logs

Heat Output

Small: 1.00 - 2.00kW



Midi: 1.00 - 2.00kW



Medium: 1.00 - 2.00kW



Command Controls

Remote as standard

Chimney Types



No Chimney Required

Efficiency figures given are based upon the maximum heat output achieved for these models.
For complete model choices, specifications and additional information please see page 62 onwards.
For Bench options please see page 79.

Riva2 F670 Glass



Riva2 F670 Glass conventional flue with optional Brick-effect Lining

Combining exceptional aesthetics with the latest gas fire innovations, the Riva2 F670 Glass provides high efficiency heating whilst effortlessly creating a stunning focal point in any setting.

The F670's realistic log-effect fire is complimented by Gazco's EchoFlame Black Glass lining, which enhances the depth of the fire by mirroring the flames on three sides. This lining can be optionally replaced with either Vermiculite, Brick-effect or Black Reeded, for an alternative backdrop to the flames.

See overleaf for the steel fronted version of the F670.

Finish

Black Glass

Linings*

EchoFlame Black Glass (as standard)

Vermiculite (optional)

Brick-effect (optional)

Black Reeded (optional)

*please see page 63 for lining details

Fuel Bed

Logs

Heat Output

2.30 - 5.10kW 

Efficiency

Conventional flue: 76%

Balanced flue: 82%

Energy Efficiency Class

Conventional flue: D

Balanced flue: C

Command Controls

Programmable Thermostatic Remote

Chimney Types

1 **2** **BF**

(please see pages 8-9)

ECHOFLAME™
BLACK GLASS LINING

Efficiency figures given are based upon the maximum heat output achieved for these models. For complete model choices, specifications and additional information please see page 62 onwards. For Bench options please see page 79.





Riva2 F670 Glass, balanced flue with EchoFlame Black Glass Lining on 120 High Bench



Riva2 F670 Steel



Riva2 F670 Steel conventional flue with optional Vermiculite Lining

Offered in a stylish Graphite steel front, the F670 Steel is an attractive alternative to the Glass model shown on the previous pages and shares all the same firebox technology and lining options.

These innovative gas stoves are capable of producing up to 5.10kW of heat, with an outstanding 82% efficiency, all with easy and convenient operation thanks to the Programmable Thermostatic handset featuring timer and thermostatic temperature controls.

Finish

Graphite

Linings*

EchoFlame Black Glass (as standard)

Vermiculite (optional)

Brick-effect (optional)

Black Reeded (optional)

*please see page 61 for lining details

Heat Output

2.30 - 5.10kW 

Efficiency

Conventional flue: 76%

Balanced flue: 82%

Energy Efficiency Class

Conventional flue: D

Balanced flue: C

Command Controls

Programmable Thermostatic Remote

Chimney Types

(please see pages 8-9)

Fuel Bed

Logs

E C H O F L A M E™
BLACK GLASS LINING

Efficiency figures given are based upon the maximum heat output achieved for these models.

For complete model choices, specifications and additional information please see page 62 onwards.

For Bench options please see page 79.

Studio 1 Freestanding Gas



Studio 1 Freestanding balanced flue with White front and matching plinth, Driftwood-effect fuel bed and EchoFlame Black Glass lining

The Studio 1 Freestanding is a designer gas stove with a wide range of styling options, allowing you to tailor your fire to your interior. Available with a choice of either a black or a white steel front, this stylish fire can also be selected with a matching plinth or bench.

In addition to the stove's exterior styling options, the Studio 1 can be configured with a choice of highly realistic fuel beds including Log-effect, Pebble & Stone and Driftwood-effect, which each transform the fire's aesthetic and ambience.

The impressive flame visuals are heightened by the highly reflective EchoFlame Black Glass lining, which enhances the depth of the firebox. Alternatively, additional Vermiculite or Black Reeded linings can be selected should you wish to further customise your Studio 1 Freestanding.

This advanced gas stove is available in either conventional or balanced flue versions to suit your home and features a Programmable Thermostatic handset for full control from the comfort of your armchair.

A larger version, the Studio 2 Freestanding, is shown overleaf.

Finish Choice

Black or White Fronted

Mounting Choices

Plinth or Bench

Heat Output

3.00 - 5.30kW 

Chimney Types

1 **2** **BF**

(please see pages 8-9)

Energy

Conventional flue: 72%

Balanced flue: 92%

Energy Efficiency Class

Conventional flue: E

Balanced flue: A

Linings[^]

EchoFlame Black Glass (as standard)

Vermiculite (optional)

Black Reeded (optional)

[^]please see page 63 for lining details

Fuel Beds

Driftwood-effect

Pebble & Stone

Log-effect

Command Controls

Programmable

Thermostatic Remote

ECHOFLAME™
BLACK GLASS LINING





*Studio 1 Freestanding conventional flue with Black front and matching bench,
Pebble & Stone fuel bed and EchoFlame Black Glass lining*



Studio 2 Freestanding balanced flue with White front and matching bench, Driftwood-effect fuel bed and EchoFlame Black Glass lining

Studio 2 Freestanding Gas



Studio 2 Freestanding conventional flue with Black front and matching plinth, Log-effect fuel bed and EchoFlame Black Glass lining

The landscape Studio 2 Freestanding offers an expansive flame view and a host of styling choices to suit your interior.

Flame visuals can be tailored with the variety of realistic fuel beds including highly detailed Log-effect, Driftwood-effect or Pebble & Stone. Each bed adds its own character to the Studio 2.

Gazco's shimmering EchoFlame Black Glass lines the Studio 2's firebox, mirroring the flames to enhance the fire's depth and visuals. There is also the option of additional Vermiculite or Black Reeded linings, which can replace the EchoFlame lining if desired.

Similar to the smaller Studio 1 Freestanding on the preceding pages, the Studio 2 can be customised with a black or white steel front, as well as a choice of either matching plinth or bench.

Finish Choice

Black or White Fronted

Mounting Choices

Plinth or Bench

Heat Output

3.30 - 7.00kW 

Chimney Types

1 **2** **BF**

(please see pages 8-9)

Energy

Conventional flue: 81%

Balanced flue: 92%

Energy Efficiency Class

Conventional flue: C

Balanced flue: A

Linings[^]

EchoFlame Black Glass (as standard)

Vermiculite (optional)

Black Reeded (optional)

[^]please see page 63 for lining details

Fuel Beds

Driftwood-effect

Pebble & Stone

Log-effect

Command Controls

Programmable

Thermostatic Remote

ECHOFLAME™
BLACK GLASS LINING

Also see image on page 76.

Efficiency figures given are based upon the maximum heat output achieved for these models.

For complete model choices, specifications and additional information please see page 62 onwards.

Additional Information

Command remote controls

Gas Stoves

Gazco was the first UK company to introduce remote controls for gas fires. Today, our Command remote control systems allow most stoves to be upgraded, either at the time of purchase or at a later date, with either:



a) Standard upgradeable remote control

Once the pilot light has been ignited manually you can vary the flame height and heat output from the comfort of your armchair.



b) Programmable Thermostatic upgradeable remote control

This deluxe version has two additional features. The first allows you to thermostatically control the room temperature whilst the second allows you to programme your stove to switch itself on and off twice a day.



c) Programmable Thermostatic remote control for Gas Loft, Gas Vision Large, Riva2 F670 and Studio Freestanding

This advanced remote is loaded with exciting features that make it possible to programme your stove to perfectly complement your lifestyle. Not only can you ignite, extinguish and thermostatically control your stove, this remote control system benefits from advanced technology that gives you the option to create an automatic, intelligent heating program that means your home is comfortable and cosy at any time of the day or night.

Electric Stoves

Our range of Electric Stoves are as easy to install as plugging in and switching on! They are available in a range of designs from traditional to modern, to suit all homes and tastes.



The Gazco VeriFlame™ Difference

Stockton, Marlborough, Huntingdon and Vision electric stoves feature VeriFlame™ technology, which provides three flame intensities, as well as a blue flame-effect that can each be selected using the handset.

Stoves with Veriflame technology feature a manual thermostatic heat control for either a 1kW or 2kW output, discreetly concealed on the body of the stove.

The Gazco Programmable Thermostatic Eco Handset



The Vogue Midi Electric stove features Gazco's Eco remote control, which provides complete control over the stove's ChromaLight flame colours and lighting effects, as well as heating and energy saving features. Ambient heating control allows you to set the optimum temperature for your room between 15°C and 25°C, with the Vogue automatically managing heating power to reach the chosen temperature as efficiently as possible. Daily and weekly heating lets you program your stove to suit your lifestyle and can be easily advanced or delayed without disrupting scheduling.

Energy saving features such as Open Window Detection save energy by turning off the heat if a sudden drop in room temperature of 4°C or more is detected, such as when a door or window is opened. Heating can be easily resumed by pressing the heat button again or closing the window.



Lining Options for Riva F670, Studio Freestanding and Vision Large

The Riva2 F670, Studio Freestanding and Vision Large stoves come with EchoFlame Black Glass as standard, with a selection of alternative interior lining options that can be added if desired:

Riva F670



EchoFlame Black Glass
(as standard)



Vermiculite (optional)



Black Reeded (optional)



Brick Effect (optional)

Studio Freestanding & Vision Large



EchoFlame Black Glass
(as standard)

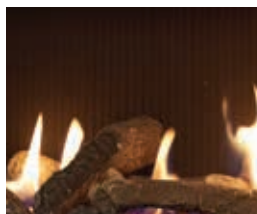

Black Reeded (optional)



Vermiculite (optional)

Technical Specifications

All specifications given in the main part of this brochure are approximate. Actual specifications for each individual product will vary according to the exact model and are given on pages 64-77. Your Gazco retailer will be pleased to help explain specific model specifications and provide any further information you may require, or you can view/download specification sheets from www.gazco.com.

Installation and Safety

Gazco gas stoves must be fitted by a qualified gas installer (Gas Safe registered in the United Kingdom or Bord Gais registered in the Republic of Ireland) who should also verify the proposed site conditions are fully suitable for the product selected. Complete installation instructions for many models can be obtained prior to purchase by downloading them from www.gazco.com.

Please note that all parts of these stoves become extremely hot during operation and can result in serious injury and burns if touched. It is therefore recommended that a fireguard complying with BS 8423:2002 is used in the presence of young children, the elderly or infirm.

Colours

Owing to variations in studio lighting and printing inks, the colours of stoves illustrated in this brochure may differ slightly from actual models.

Product Improvement & Brochure Photography

Gazco pursue a policy of continuous product improvement, therefore, whilst our products are correct at the time of the photography, we reserve the right to make alterations and amendments. Exact product

details should be discussed with your retailer at the time of purchase.

All fire and flame photography has been taken from genuine products; however, the exact appearance of the flame picture for any appliance will vary depending on the nature of the flue type, installation surroundings, local geographical features and the way in which the appliance is operated.

Given that building regulations are subject to constant change, some of the photography in this brochure may not comply with the requirements of the latest Building Regulations and you should always check your proposed installation arrangement with your qualified gas installer before proceeding. Certain settings in this brochure are dependant on the use of heat shields to reduce the required separation from combustible material.

Please note: The operation and appearance of gas appliances depends on variable factors such as the gas pressure supplied.

Warranty information

Your Gazco Expert Retailer will provide you with a Two Year Warranty for your new gas or electric stove. The warranty for gas stoves can be extended to a period of Five years by registering your stove with Gazco. Please note, these warranties exclude certain consumable parts. Stoves purchased outside of Gazco's Expert Retailer Network will carry a standard 1 Year non-extendable Warranty. Full warranty terms & conditions are available to view at www.gazco.com.



GAS STOVES - dimensions and options

Model	Overall dimensions (mm)			Approx weight (kg)	Conventional or Pre-fabricated flue
	Width	Height	Depth		
Gas Marlborough2 - Matt Black only					
Small	410	533	360	35	✓
Medium	590	583	410	48	✓

Gas Stockton - Matt Black only					
Small	422	525	340	57	✓
Stockton 5	481	544	337	55	✓
Medium	579	618	411	77	✓

Gas Huntingdon - Matt Black, Matt Ivory and Ivory Enamel					
Gas Huntingdon 20	416	535	320	45	-
Gas Huntingdon 30	560	592	351	72	✓
Gas Huntingdon 40	641	653	382	CF: 71 BF: 75	-

Gas Riva2 F670 - Black Glass and Steel					
Riva2 F670	737	572	385	CF: 52 BF: 54	-

Loft - Black Glass with Matt Black					
Loft	481	770	359	CF: 54 BF: 55	-
Loft Wall Mounted	481	770	399	BF: 55	-

Gas Vogue - Matt Black only					
Midi	416	639	CF: 367 BF: 348	CF: 42 BF: 40	-
Midline	416	791	CF: 367 BF: 348	CF: 47 BF: 47	-
Midi T	416	776	CF: 367 BF: 348	CF: 54 BF: 55	-
Midi T Midline	416	926	CF: 367 BF: 348	CF: 61 BF: 62	-
Midi T Highline	416	1260	CF: 367 BF: 348	CF: 82 BF: 83	-
Midi T Wall Mounted	416	776	360	BF: 62	-

Gas Vision - Black Glass					
Small - Conventional Flue	370	529	289	33	-
Midi - Conventional Flue	415	605	311	CF: 39 BF: 41	-
Medium - Conventional Flue	535	677	353	CF: 45 BF: 55	-
Large - Conventional Flue	876	CF: 631 BF: 656	CF: 390 BF: 375	CF: 74.5 BF: 78.5	-

Gas Studio Freestanding - Black and White					
Studio Freestanding 1 - Bench Mounted	896	1150	396	146	-
Studio Freestanding 1 - Plinth Mounted	649	1105	485	141.5	-
Studio Freestanding 2 - Bench Mounted	896	1350	396	148	-
Studio Freestanding 2 - Plinth Mounted	649	1305	485	143.5	-

GAS FLUE SYSTEMS

1. Rigid or Flexible Metal Flue^Δ

With this flue system rigid metal tubes, or a combination of rigid and flexible metal tubes, extend vertically directly from the stove to the outside of the property. This may be either straight through the ceiling or roof with the flue pipe exposed, or by using the channel of a chimney or a studwork enclosure. The products of combustion are carried up the flue by natural convection.

Models which can use this system are:

Small and Medium Gas Marlborough2, Small and Medium Gas Stockton2, Gas Stockton 5, Huntingdon 20, Huntingdon 30, Huntingdon 40, Loft, Gas Vogue, Gas Vision Small, Midi, Medium & Large[†], Studio 1 and 2 Freestanding and Riva2 F670. ([†] Top outlet only)

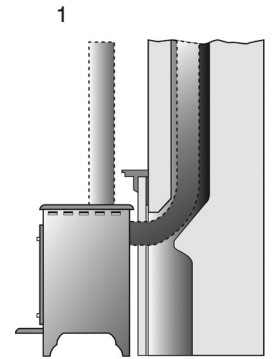

2. Balanced Flue

Where a room has no chimney, then a Balanced Flue version of a Gazco stove is a practical option. The flue consists of one tube inside another. The outer tube brings air into the stove for combustion whilst the inner one emits the products of combustion.

Options: A - Rear outlet (max 600mm wall thickness).

B - Top outlet/up and out (min rise 500mm, max 3m), horizontal (min 250mm, max 5m).

An additional bend can be incorporated in to the horizontal section of the 'up and out', dependent upon a 1m min vertical rise.

C - Top outlet/vertical (min 3m, max 10m). Vogue Midi T / Vogue Midi T Midline (Min 2m, Max 10m)

D - Top outlet/vertical with offset (min to first bend 500mm, max flue length 10m).

Ask your retailer for full technical details or see our Concentric Flue System brochure at www.gazco.com.

Models which can use this system are:

Small* and Medium Gas Marlborough2, Small* and Medium Gas Stockton2, Gas Stockton 5, Gas Huntingdon 20*, 30 and 40, Small*, Loft, Gas Vogue, Gas Vision Small, Midi, Medium & Large[†]. Studio 1 and 2 Freestanding and Riva2 F670. (*Rear outlet only [†] Top outlet only). All Balanced Flue models are log effect only.

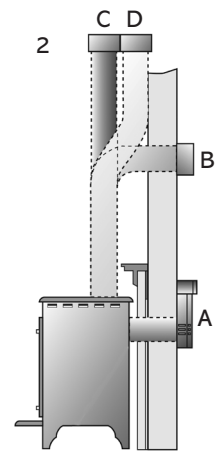

Gas Stockton 5 balanced flue with log-effect fire

ELECTRIC STOVES - dimensions and options

Model	Overall dimensions (mm)			Approx weight (kg)	Log Fire
	W	H	D		Electric No flue req.
Electric Marlborough2 - Matt Black only					
Small	410	559	360	35	✓
Medium	590	583	410	48	✓
Electric Stockton - Matt Black only					
Small	422	525	340	57	✓
Stockton 5	481	544	337	55	✓
Medium	579	618	411	82	✓
Electric Huntingdon - Matt Black, Matt Ivory and Ivory					
Huntingdon 20	413	536	324	35	✓
Huntingdon 30	560	592	351	52	✓
Huntingdon 40	641	653	397	59.5	✓
Vogue Midi Electric - Matt Black only					
Midi	416	639	348	42	✓
Midi Midline	416	791	348	49.4	✓
Electric Vision - Black Glass					
Small	370	555	297	24	✓
Midi	415	604	317	28	✓
Medium	535	676	363	38	✓



Gas and Electric Marlborough2

Product Code	Model	Colour	Flue Type	Logs/ Coals	Fuel Type	Heat Input	Heat Output	Efficiency	Energy Efficiency Class
⊗ 559-009	Small	Matt Black	Conventional	Logs	Nat.Gas	3.30kW	2.30kW	76%	E*
⊗ 559-448	Small	Matt Black	Conventional	Logs	LPG	3.20kW	2.20kW	76%	E*
⊗ 559-024	Small	Matt Black	Balanced	Logs	Nat.Gas	3.20kW	2.50kW	85.1%	C*
⊗ 559-462	Small	Matt Black	Balanced	Logs	LPG	3.10kW	2.40kW	85.1%	C*
⊗ 559-018	Medium	Matt Black	Conventional	Logs	Nat Gas	6.60kW	4.60kW	78%	E*
⊗ 559-456	Medium	Matt Black	Conventional	Logs	LPG	6.70kW	4.80kW	78%	E*
⊗ 559-033	Medium	Matt Black	Balanced	Logs	Nat Gas	6.60kW	5.40kW	90.8%	B*
⊗ 559-471	Medium	Matt Black	Balanced	Logs	LPG	6.60kW	5.50kW	90.8%	B*
⊗ 659-019	Small	Matt Black	N/A	Logs	Elec	-	2.00kW	-	-
⊗ 659-033	Medium	Matt Black	N/A	Logs	Elec	-	2.00kW	-	-

When upgraded with a Programmable Thermostatic Control (8456)

Marlborough2 Dimensions (see letters on diagram)

	A	B	C	D	E	F
	mm	mm	mm	mm	mm	mm
Small Marlborough2 (CF)	429	533*	355	280	349	110
Medium Marlborough2 (CF)	600	583	406	330	395	100
Small Marlborough2 (BF)	429	533	355	280	369	112
Medium Marlborough2 (BF)	600	583	406	330	445	128

* Small Electric Marlborough2 is 15mm taller.

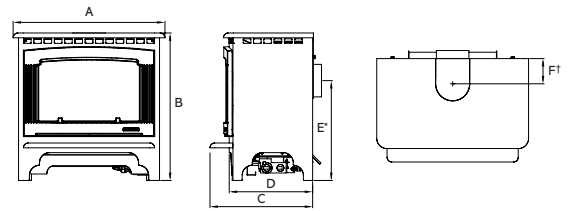

† (Balanced flue version 5 1/4" 134mm).

* (Small balanced flue version 14 1/2" 370mm).

† (Medium balanced flue version 17 7/8" 453mm).

Recommended clearances between stove and other surfaces: top 9" (225mm), sides 6" (150mm), rear must be a minimum of 2" (50mm).

The Marlborough2 has a choice of top or rear flue exit and can be supplied with an optional rear closure plate: Small (**8108**), Medium (**8109**). Small balanced flue stoves are rear exit only.

Stove Flue Pipe

Balanced flue versions of the Gas Marlborough2 must only use the 6" stainless steel flue provided. For additional Matt Black flue collars, please see the Gazco Stoves price list. Gazco recommends the use of 5" matt black enamelled stove pipe with the conventional flue version Marlborough2 stove. The components usually required are:

Description	Product Code
1' Straight pipe	4500
2' Straight pipe	4501
3' Straight pipe	4502
90° long 'elbow' adaptor (9" projection)	4514
Flue collar	8549

Remote Controls for Gas Marlborough2

Description	Product Code
Standard Upgradeable Remote Control	8455
Programmable Thermostatic Upgradeable Remote	8456

Gas and Electric Stockton2 and Stockton 5

Product Code	Model	Colour	Flue Type	Logs/ Coals	Fuel Type	Heat Input	Heat Output	Efficiency	Energy Efficiency Class
⊗ 504-053	Small	Matt Black	Conventional	Logs	Nat Gas	3.30kW	2.30kW	76%	E*
⊗ 504-513	Small	Matt Black	Conventional	Logs	LPG	3.20kW	2.20kW	76%	E*
⊗ 504-078	Small	Matt Black	Balanced	Logs	Nat Gas	3.20kW	2.50kW	85.1%	C*
⊗ 504-536	Small	Matt Black	Balanced	Logs	LPG	3.10kW	2.40kW	85.1%	C*
⊗ 8575MCUC	5	Matt Black	Conventional	Coal	Nat Gas	4.60kW	3.00kW	73%	E*
⊗ P8575MCUC	5	Matt Black	Conventional	Coal	LPG	4.40kW	3.00kW	73%	E*
⊗ 8563LUC	5	Matt Black	Balanced	Logs	Nat Gas	4.25kW	3.50kW	91.8%	B*
⊗ P8563LUC	5	Matt Black	Balanced	Logs	LPG	4.10kW	3.50kW	84.5%	B*
⊗ 504-066	Medium	Matt Black	Conventional	Logs	Nat Gas	6.60kW	4.60kW	78%	E*
⊗ 504-522	Medium	Matt Black	Conventional	Logs	LPG	6.70kW	4.80kW	78%	E*
⊗ 504-085	Medium	Matt Black	Balanced	Logs	Nat Gas	6.60kW	5.40kW	90.8%	B*
⊗ 504-547	Medium	Matt Black	Balanced	Logs	LPG	6.60kW	5.50kW	90.8%	B*
⊗ 604-074	Small	Matt Black	N/A	Logs	Elec	-	2.00kW	-	-
⊗ E8575	5	Matt Black	N/A	Logs	Elec	-	2.00kW	-	-
⊗ 604-095	Medium	Matt Black	N/A	Logs	Elec	-	2.00kW	-	-

When upgraded with a Programmable Thermostatic Control (8456)

Stockton Dimensions (see letters on diagram)

	A	B	C	D	E	F
	mm	mm	mm	mm	mm	mm
Small Stockton2 (CF)	438	525	290	348	108	50
Stockton 5 (CF)	481	544	273	380	92	64
Medium Stockton2 (CF)	601	616	347	431	107	65
Small Stockton2 (BF)	438	525	290	368	108	50
Stockton 5 (BF)	481	544	273	380	92	64
Medium Stockton2 (BF)	601	616	347	481	135	65

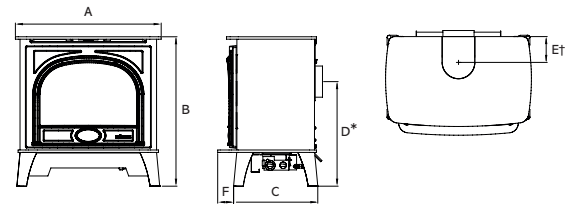

† (Balanced flue version 5 1/2" 140mm).

* (Small balanced flue version 14 1/2" 366mm)

† (Medium balanced flue version 19" 482mm)

* (Stockton 5 balanced flue 15 1/4" 401mm)

Recommended clearances between stove and other surfaces: top 9" (225mm), sides 6" (150mm), rear must be a minimum of 2" (50mm).

The Stockton has a choice of top or rear flue exit. Small and medium models can be supplied with an optional rear closure plates: Small (**8042**), Medium (**8105**). Small balanced flue stoves are rear exit only.

Stove Flue Pipe

Balanced flue versions of the Gas Stockton must only use the 6" stainless steel flue provided. For additional Matt Black, please see the Gazco Stoves price list. Gazco recommends the use of 5" Matt Black enamelled stove pipe with the conventional flue version. The components required are:

Description	Product Code
1' Straight pipe	4500
2' Straight pipe	4501
3' Straight pipe	4502
90° Long 'elbow' adaptor (9" projection)	4514
Flue collar	8549

Remote Controls for Gas Stockton

Description	Product Code
Standard Upgradeable Remote Control	8455
Programmable Thermostatic Upgradeable Remote	8456

The above information is to assist in your choice of a suitable Gazco stove. This is not intended to be all the information required to install your stove. This can be obtained from your local Gazco retailer or you can download the full installation instructions from the Gazco website at www.gazco.com

Gas and Electric Huntingdon 20

Gas & Electric Huntingdon 20 Tracery Door

Product Code	Colour	Flue Type	Fuel Effect	Fuel Type	Heat Input	Heat Output	Efficiency	Energy Efficiency Class
⊗ 515-035	Matt Black	Conventional	Logs	Nat Gas	3.30kW	2.30kW	76%	E#
⊗ 515-405	Matt Black	Conventional	Logs	LPG	3.20kW	2.20kW	76%	E#
⊗ 515-044	Ivory	Conventional	Logs	Nat Gas	3.30kW	2.30kW	76%	E#
⊗ 515-423	Ivory	Conventional	Logs	LPG	3.20kW	2.20kW	76%	E#
⊗ 515-053	Matt Ivory	Conventional	Logs	Nat Gas	3.30kW	2.30kW	76%	E#
⊗ 515-432	Matt Ivory	Conventional	Logs	LPG	3.20kW	2.20kW	76%	E#
⊗ 515-098	Matt Black	Balanced	Logs	Nat Gas	3.20kW	2.50kW	85.1%	C#
⊗ 515-502	Matt Black	Balanced	Logs	LPG	3.10kW	2.40kW	85.1%	C#
⊗ 515-107	Ivory	Balanced	Logs	Nat Gas	3.20kW	2.50kW	85.1%	C#
⊗ 515-511	Ivory	Balanced	Logs	LPG	3.10kW	2.40kW	85.1%	C#
⊗ 515-116	Matt Ivory	Balanced	Logs	Nat Gas	3.20kW	2.50kW	85.1%	C#
⊗ 515-520	Matt Ivory	Balanced	Logs	LPG	3.10kW	2.40kW	85.1%	C#
⊗ 615-461	Matt Black	N/A	Logs	Electric	-	2.00kW	-	-
⊗ 615-495	Ivory	N/A	Logs	Electric	-	2.00kW	-	-
⊗ 615-483	Matt Ivory	N/A	Logs	Electric	-	2.00kW	-	-

Gas & Electric Huntingdon 20 Clear Door

⊗ 515-071	Matt Black	Conventional	Logs	Nat Gas	3.30kW	2.30kW	76%	E#
⊗ 515-441	Matt Black	Conventional	Logs	LPG	3.20kW	2.20kW	76%	E#
⊗ 515-080	Ivory	Conventional	Logs	Nat Gas	3.30kW	2.30kW	76%	E#
⊗ 515-468	Ivory	Conventional	Logs	LPG	3.20kW	2.20kW	76%	E#
⊗ 515-089	Matt Ivory	Conventional	Logs	Nat Gas	3.30kW	2.30kW	76%	E#
⊗ 515-477	Matt Ivory	Conventional	Logs	LPG	3.20kW	2.20kW	76%	E#
⊗ 515-125	Matt Black	Balanced	Logs	Nat Gas	3.20kW	2.50kW	85.1%	C#
⊗ 515-529	Matt Black	Balanced	Logs	LPG	3.10kW	2.40kW	85.1%	C#
⊗ 515-134	Ivory	Balanced	Logs	Nat Gas	3.20kW	2.50kW	85.1%	C#
⊗ 515-545	Ivory	Balanced	Logs	LPG	3.10kW	2.40kW	85.1%	C#
⊗ 515-143	Matt Ivory	Balanced	Logs	Nat Gas	3.20kW	2.50kW	85.1%	C#
⊗ 515-556	Matt Ivory	Balanced	Logs	LPG	3.10kW	2.40kW	85.1%	C#
⊗ 615-475	Matt Black	N/A	Logs	Electric	-	2.00kW	-	-
⊗ 615-499	Ivory	N/A	Logs	Electric	-	2.00kW	-	-
⊗ 615-490	Matt Ivory	N/A	Logs	Electric	-	2.00kW	-	-

When upgraded with a Programmable Thermostatic Control (8456)

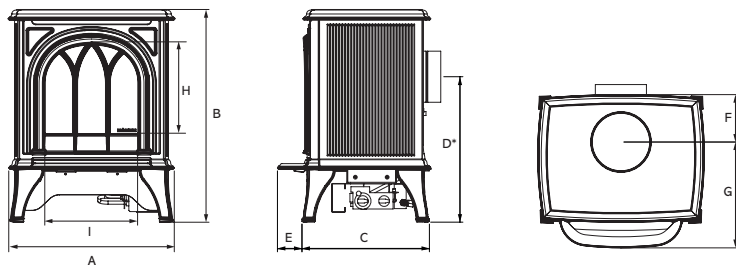

Huntingdon 20 Dimensions mm (see letters on diagram)

	A	B	C	D	E	F	G	H	I
Huntingdon 20 (CF)	416	535	320	366	62	119	266	223	234
Huntingdon 20 (BF)*	416	535	320	386	62	160	225	223	234

*Huntingdon 20 Balanced Flue is Rear Exit only.

Recommended clearances between stove and other surfaces:

top 9" (225mm), sides 6" (150mm), rear must be a minimum of 2" (50mm).

The Huntingdon 20 conventional flue has a choice of top or rear flue exit.

Stove Flue Pipe

Balanced flue versions of the Gas Huntingdon 20 must only use the 6" stainless steel flue provided. For additional Matt Black, Matt Ivory and Ivory enamelled flue collars, please see the Gazco Stoves price list. Gazco recommends the use of 5" Matt Black enamelled stove pipe with the conventional flue version. The components required are:

Description

1' Straight pipe, Matt Black	4500
2' Straight pipe, Matt Black	4501
3' Straight pipe, Matt Black	4502
90° long 'elbow' adaptor (9" projection), Matt Black	4514
1' Straight pipe, Ivory	4500IV
2' Straight pipe, Ivory	4501IV
3' Straight pipe, Ivory	4502IV
1' Straight pipe, Matt Ivory	4500PI
2' Straight pipe, Matt Ivory	4501PI
3' Straight pipe, Matt Ivory	4502PI
Matt Black Flue collar, Conventional Flue, Huntingdon	999-010
Matt Ivory Flue collar, Conventional Flue, Huntingdon	999-266
Ivory Enamel Flue collar, Conventional Flue, Huntingdon	999-456

Remote Controls for Gas Huntingdon 20

Description

Standard Upgradeable Remote Control	8455
Programmable Thermostatic Upgradeable Remote Control	8456



Gas Huntingdon 20 with Tracery Door in Matt Black

Gas and Electric Huntingdon 30

Gas and Electric Huntingdon 30 Tracery Door

Product Code	Colour	Flue Type	Fuel Effect	Fuel Type	Heat Input	Heat Output	Efficiency	Energy Efficiency Class
⊗ 515-004	Matt Black	Conventional	Logs	Nat Gas	4.55kW	3.10kW	75%	E
⊗ 515-413	Matt Black	Conventional	Logs	LPG	4.55kW	3.00kW	75%	E
⊗ 515-154	Ivory	Conventional	Logs	Nat Gas	4.55kW	3.10kW	75%	E
⊗ 515-484	Ivory	Conventional	Logs	LPG	4.55kW	3.00kW	75%	E
⊗ 515-212	Matt Ivory	Conventional	Logs	Nat Gas	4.55kW	3.10kW	75%	E
⊗ 515-536	Matt Ivory	Conventional	Logs	LPG	4.55kW	3.00kW	75%	E
⊗ 8503CFMCUC	Matt Black	Conventional	Coals	Nat Gas	4.60kW	3.50kW	76%	E
⊗ P8503CFMCUC	Matt Black	Conventional	Coals	LPG	4.40kW	3.35kW	76%	E
⊗ 8503CFMCUCIV	Ivory	Conventional	Coals	Nat Gas	4.60kW	3.50kW	76%	E
⊗ P8503CFMCUCIV	Ivory	Conventional	Coals	LPG	4.40kW	3.35kW	76%	E
⊗ 515-013	Matt Ivory	Conventional	Coals	Nat Gas	4.60kW	3.50kW	76%	E
⊗ 515-494	Matt Ivory	Conventional	Coals	LPG	4.40kW	3.35kW	76%	E
⊗ 515-257	Matt Black	Balanced	Logs	Nat Gas	4.30kW	3.70kW	95.4%	A#
⊗ 515-561	Matt Black	Balanced	Logs	LPG	4.30kW	3.80kW	95.4%	A#
⊗ 515-395	Ivory	Balanced	Logs	Nat Gas	4.30kW	3.70kW	95.4%	A#
⊗ 515-664	Ivory	Balanced	Logs	LPG	4.30kW	3.80kW	95.4%	A#
⊗ 515-333	Matt Ivory	Balanced	Logs	Nat Gas	4.30kW	3.70kW	95.4%	A#
⊗ 515-712	Matt Ivory	Balanced	Logs	LPG	4.30kW	3.80kW	95.4%	A#
⊗ E8503	Matt Black	N/A	Logs	Elec	-	2.00kW	-	-
⊗ E8503IV	Ivory	N/A	Logs	Elec	-	2.00kW	-	-
⊗ 615-567	Matt Ivory	N/A	Logs	Elec	-	2.00kW	-	-

Gas & Electric Huntingdon 30 Clear Door

⊗ 515-009	Matt Black	Conventional	Logs	Nat Gas	4.55kW	3.10kW	75%	E
⊗ 515-453	Matt Black	Conventional	Logs	LPG	4.55kW	3.00kW	75%	E
⊗ 515-061	Ivory	Conventional	Logs	Nat Gas	4.55kW	3.10kW	75%	E
⊗ 515-505	Ivory	Conventional	Logs	LPG	4.55kW	3.00kW	75%	E
⊗ 515-100	Matt Ivory	Conventional	Logs	Nat Gas	4.55kW	3.10kW	75%	E
⊗ 515-570	Matt Ivory	Conventional	Logs	LPG	4.55kW	3.00kW	75%	E
⊗ 515-282	Matt Black	Conventional	Coals	Nat Gas	4.60kW	3.50kW	76%	E
⊗ 515-778	Matt Black	Conventional	Coals	LPG	4.40kW	3.35kW	76%	E
⊗ 515-348	Ivory	Conventional	Coals	LPG	4.60kW	3.50kW	76%	E
⊗ 515-796	Ivory	Conventional	Coals	LPG	4.40kW	3.35kW	76%	E
⊗ 515-299	Matt Ivory	Conventional	Coals	Nat Gas	4.60kW	3.50kW	76%	E
⊗ 515-698	Matt Ivory	Conventional	Coals	LPG	4.40kW	3.35kW	76%	E
⊗ 515-139	Matt Black	Balanced	Logs	Nat Gas	4.30kW	3.70kW	95.4%	A#
⊗ 515-726	Matt Black	Balanced	Logs	LPG	4.30kW	3.80kW	95.4%	A#
⊗ 515-165	Ivory	Balanced	Logs	Nat Gas	4.30kW	3.70kW	95.4%	A#
⊗ 515-739	Ivory	Balanced	Logs	LPG	4.30kW	3.80kW	95.4%	A#
⊗ 515-191	Matt Ivory	Balanced	Logs	Nat Gas	4.30kW	3.70kW	95.4%	A#
⊗ 515-765	Matt Ivory	Balanced	Logs	LPG	4.30kW	3.80kW	95.4%	A#
⊗ 615-552	Matt Black	N/A	Logs	Electric	-	2.00kW	-	-
⊗ 615-573	Ivory	N/A	Logs	Electric	-	2.00kW	-	-
⊗ 615-564	Matt Ivory	N/A	Logs	Electric	-	2.00kW	-	-

When upgraded with a Programmable Thermostatic Control (8456)

Stove Flue Pipe

Balanced flue versions of the Gas Huntingdon 30 must only use the 6" stainless steel flue provided. For additional Matt Black, Matt Ivory and Ivory enamelled flue collars, please see the Gazco Stoves price list. Gazco recommends the use of 5" Matt Black enamelled stove pipe with the conventional flue version. The components required are:

Description	Product Code
1' Straight pipe, Matt Black	4500
2' Straight pipe, Matt Black	4501
3' Straight pipe, Matt Black	4502
90° long 'elbow' adaptor (9" projection), Matt Black	4514
1' Straight pipe, Ivory	4500IV
2' Straight pipe, Ivory	4501IV
3' Straight pipe, Ivory	4502IV
1' Straight pipe, Matt Ivory	4500PI
2' Straight pipe, Matt Ivory	4501PI
3' Straight pipe, Matt Ivory	4502PI
Matt Black Flue collar, Conventional Flue, Huntingdon	999-010
Matt Black Flue collar, Balanced Flue, Huntingdon	999-347
Matt Ivory Flue collar, Conventional Flue, Huntingdon	999-266
Matt Ivory Flue collar, Balanced Flue, Huntingdon	999-507
Ivory Enamel Flue collar, Conventional Flue, Huntingdon	999-456
Ivory Enamel Flue collar, Balanced Flue, Huntingdon	999-683

Remote Controls for Gas Huntingdon 30

Description	Product Code
Standard Upgradeable Remote	8455
Programmable Thermostatic Upgradeable Remote	8456

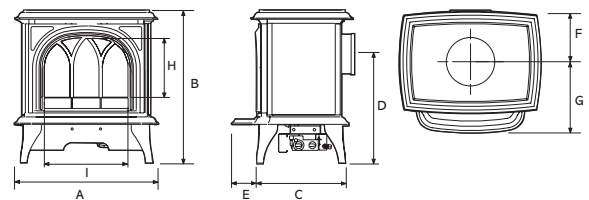

Huntingdon 30 Dimensions mm (see letters on diagram)

	A	B	C	D	E	F	G	H	I
Huntingdon 30 (Conv. Flue)	560	592	351	403	96	174	304	230	323
Huntingdon 30 (Bal. Flue)	560	592	351	422	96	195	278	230	323

Recommended clearances between stove and other surfaces:
top 9" (225mm), sides 6" (150mm), rear must be a minimum of 2" (50mm).
The Huntingdon 30 has a choice of top or rear flue exit.

Gas and Electric Huntingdon 40

Gas & Electric Huntingdon 40 Tracery Door

Product Code	Colour	Flue Type	Fuel Effect	Fuel Type	Heat Input	Heat Output	Efficiency	Energy Efficiency Class
⊗ 515-161	Matt Black	Conventional	Logs	Nat Gas	6.60kW	4.60kW	78%	E
⊗ 515-565	Matt Black	Conventional	Logs	LPG	6.70kW	4.80kW	78%	E
⊗ 515-170	Ivory	Conventional	Logs	Nat Gas	6.60kW	4.60kW	78%	E
⊗ 515-574	Ivory	Conventional	Logs	LPG	6.70kW	4.80kW	78%	E
⊗ 515-179	Matt Ivory	Conventional	Logs	Nat Gas	6.60kW	4.60kW	78%	E
⊗ 515-583	Matt Ivory	Conventional	Logs	LPG	6.70kW	4.80kW	78%	E
⊗ 515-224	Matt Black	Balanced	Logs	Nat Gas	6.60kW	5.40kW	90.8%	B#
⊗ 515-628	Matt Black	Balanced	Logs	LPG	6.60kW	5.50kW	90.8%	B#
⊗ 515-233	Ivory	Balanced	Logs	Nat Gas	6.60kW	5.40kW	90.8%	B#
⊗ 515-646	Ivory	Balanced	Logs	LPG	6.60kW	5.50kW	90.8%	B#
⊗ 515-242	Matt Ivory	Balanced	Logs	Nat Gas	6.60kW	5.40kW	90.8%	B#
⊗ 515-655	Matt Ivory	Balanced	Logs	LPG	6.60kW	5.50kW	90.8%	B#
⊗ 615-501	Matt Black	N/A	Logs	Electric	-	2.00kW	-	-
⊗ 615-527	Ivory	N/A	Logs	Electric	-	2.00kW	-	-
⊗ 615-514	Matt Ivory	N/A	Logs	Electric	-	2.00kW	-	-

Gas & Electric Huntingdon 40 Clear Door

⊗ 515-188	Matt Black	Conventional	Logs	Nat Gas	6.60kW	5.10kW	78%	E
⊗ 515-592	Matt Black	Conventional	Logs	LPG	6.70kW	5.20kW	78%	E
⊗ 515-197	Ivory	Conventional	Logs	Nat Gas	6.60kW	5.10kW	78%	E
⊗ 515-601	Ivory	Conventional	Logs	LPG	6.70kW	5.20kW	78%	E
⊗ 515-206	Matt Ivory	Conventional	Logs	Nat Gas	6.60kW	5.10kW	78%	E
⊗ 515-619	Matt Ivory	Conventional	Logs	LPG	6.70kW	5.20kW	78%	E
⊗ 515-251	Matt Black	Balanced	Logs	Nat Gas	6.60kW	5.40kW	90.8%	B#
⊗ 515-673	Matt Black	Balanced	Logs	LPG	6.60kW	5.40kW	90.8%	B#
⊗ 515-269	Ivory	Balanced	Logs	Nat Gas	6.60kW	5.40kW	90.8%	B#
⊗ 515-682	Ivory	Balanced	Logs	LPG	6.60kW	5.40kW	90.8%	B#
⊗ 515-278	Matt Ivory	Balanced	Logs	Nat Gas	6.60kW	5.40kW	90.8%	B#
⊗ 515-691	Matt Ivory	Balanced	Logs	LPG	6.60kW	5.40kW	90.8%	B#
⊗ 615-520	Matt Black	N/A	Logs	Electric	-	2.00kW	-	-
⊗ 615-545	Ivory	N/A	Logs	Electric	-	2.00kW	-	-
⊗ 615-536	Matt Ivory	N/A	Logs	Electric	-	2.00kW	-	-

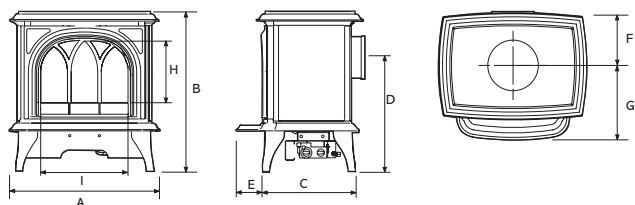

Huntingdon 40 Dimensions mm (see letters on diagram)

	A	B	C	D	E	F	G	H	I
Huntingdon 40 (CF)	641	653	382	460	99	154	350	265	402
Huntingdon 40 (BF)	641	653	382	510	99	183	321	265	402

Stove Flue Pipe

Balanced flue versions of the Gas Huntingdon 40 must only use the 6" stainless steel flue provided. For additional Matt Black, Matt Ivory and Ivory enamelled flue collars, please see the Gazco Stoves price list. Gazco recommends the use of 5" Matt Black enamelled stove pipe with the conventional flue version. The components required are:

Description	Product Code
1' Straight pipe, Matt Black	4500
2' Straight pipe, Matt Black	4501
3' Straight pipe, Matt Black	4502
90° long 'elbow' adaptor (9" projection), Matt Black	4514
1' Straight pipe, Ivory	4500IV
2' Straight pipe, Ivory	4501IV
3' Straight pipe, Ivory	4502IV
1' Straight pipe, Matt Ivory	4500PI
2' Straight pipe, Matt Ivory	4501PI
3' Straight pipe, Matt Ivory	4502PI
Matt Black Flue collar, Conventional Flue, Huntingdon	999-010
Matt Black Flue collar, Balanced Flue, Huntingdon	999-347
Matt Ivory Flue collar, Conventional Flue, Huntingdon	999-266
Matt Ivory Flue collar, Balanced Flue, Huntingdon	999-507
Ivory Enamel Flue collar, Conventional Flue, Huntingdon	999-456
Ivory Enamel Flue collar, Balanced Flue, Huntingdon	999-683

Remote Controls for Gas Huntingdon 30

Description	Product Code
Standard Upgradeable Remote Control	8455
Programmable Thermostatic Upgradeable Remote Control	8456

Recommended clearances between stove and other surfaces:
top 9" (225mm), sides 6" (150mm), rear must be a minimum of 2" (50mm).
The Huntingdon 40 has a choice of top or rear flue exit.

When upgraded with a Programmable Thermostatic Control (8456)

Gas & Electric Vogue

Product Code	Model	Flue Type	Logs/ Coals	Fuel Type	Heat Input	Heat Output	Efficiency	Energy Efficiency Class
⊗ 563-123	Midi	Conventional	Logs	Nat.Gas	6.20kW	4.20kW	76%	E#
⊗ 563-426	Midi	Conventional	Logs	LPG	5.40kW	4.30kW	76%	E#
⊗ 563-016	Midi	Balanced	Logs	Nat.Gas	4.80kW	3.90kW	90.6%	B#
⊗ 563-400	Midi	Balanced	Logs	LPG	4.80kW	4.00kW	90.6%	B#
⊗ 563-392	Midi Midline	Conventional	Logs	Nat.Gas	6.20kW	4.20kW	76%	E#
⊗ 563-466	Midi Midline	Conventional	Logs	LPG	5.40kW	4.30kW	76%	E#
⊗ 563-258	Midi Midline	Balanced	Logs	Nat.Gas	4.80kW	3.90kW	90.6%	B#
⊗ 563-790	Midi Midline	Balanced	Logs	LPG	4.80kW	4.00kW	90.6%	B#
⊗ 563-180	Midi T, 3 Sided	Conventional	Logs	Nat.Gas	6.20kW	4.40kW	78%	E#
⊗ 563-701	Midi T, 3 Sided	Conventional	Logs	LPG	5.90kW	4.20kW	78%	E#
⊗ 563-025	Midi T, 3 Sided	Balanced	Logs	Nat.Gas	5.70kW	4.80kW	94.3%	A#
⊗ 563-749	Midi T, 3 Sided	Balanced	Logs	LPG	5.00kW	4.30kW	94.3%	A#
⊗ 563-224	Midi T Midline, 3 Sided	Conventional	Logs	Nat.Gas	6.20kW	4.40kW	78%	E#
⊗ 563-493	Midi T Midline, 3 Sided	Conventional	Logs	LPG	5.90kW	4.20kW	78%	E#
⊗ 563-300	Midi T Midline, 3 Sided	Balanced	Logs	Nat.Gas	5.70kW	4.80kW	94.3%	A#
⊗ 563-676	Midi T Midline, 3 Sided	Balanced	Logs	LPG	5.00kW	4.30kW	94.3%	A#
⊗ 563-191	Midi T Highline, 3 Sided	Conventional	Logs	Nat.Gas	6.20kW	4.40kW	78%	E#
⊗ 563-447	Midi T Highline, 3 Sided	Conventional	Logs	LPG	5.90kW	4.20kW	78%	E#
⊗ 563-216	Midi T Highline, 3 Sided	Balanced	Logs	Nat.Gas	5.70kW	4.80kW	94.3%	A#
⊗ 563-458	Midi T Highline, 3 Sided	Balanced	Logs	LPG	5.00kW	4.30kW	94.3%	A#
⊗ 563-013	Midi T, 3 Sided, Wall Mounted	Balanced	Logs	Nat.Gas	5.70kW	4.80kW	94.3%	A#
⊗ 563-506	Midi T, 3 Sided, Wall Mounted	Balanced	Logs	LPG	5.00kW	4.30kW	94.3%	A#
⊗ 663-806	Vogue Midi Electric	-	-	-	-	-	-	-
⊗ 663-834	Vogue Midi Midline Electric	-	-	-	-	-	-	-

When upgraded with a Programmable Thermostatic Control (8456)

Vogue Dimensions mm (see letters on diagram)

	A	B	C	D	E	F	G
Vogue Gas Midi (CF)	639	416	367	208	121	478	11
Vogue Gas Midi (BF)	639	416	348	208	137	470	11
Vogue Gas Midi Midline (CF)	791	416	367	208	121	630	11
Vogue Gas Midi Midline (BF)	791	416	348	208	137	622	11
Vogue Gas Midi T (CF)	776	416	367	208	121	615	11
Vogue Gas Midi T (BF)	776	416	348	208	137	607	11
Vogue Gas Midi T Midline (CF)	928	416	367	208	121	767	11
Vogue Gas Midi T Midline (BF)	928	416	348	208	137	607	11
Vogue Gas Midi T Highline (CF)	1260	416	348	208	121	1099	11
Vogue Gas Midi T Highline (BF)	1260	416	348	208	137	1091	11
Vogue Gas Midi T Wall Mounted (BF)	776	416	348	208	137	607	11
Vogue Electric Midi	639	416	348	-	-	-	-
Vogue Electric Midi Midline	791	416	348	-	-	-	-

Remote Controls for Gas Vogue

Standard Upgradeable Remote	8455
Programmable Thermostatic Upgradeable Remote	8456

Stove Flue Pipes

Balanced flue versions of the Gas Vogue Midi and Midi T must only use the 6" stainless steel flue provided. For additional Matt Black enamelled flue collars, please see the Gazco Stoves price list. Gazco recommends the use of 5" matt black enamelled stove pipe with the conventional flue version of the Gas Vogue Midi and Midi T. The components usually required are:

Description	Product Code
1' Straight pipe	4500
2' Straight pipe	4501
3' Straight pipe	4502
90° Long 'elbow' adaptor (9" projection)	4514
Flue collar	8549

Gas Vogue Dimensions

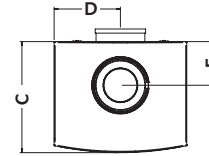
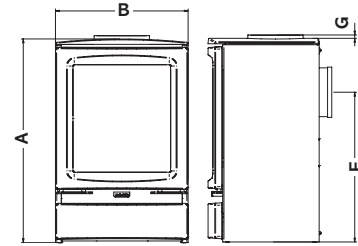

Recommended clearances between stove and other surfaces: top 9" (225mm), sides 6" (150mm) rear must be a minimum of 2" (50mm).

The complete range of Gas Vogue stoves have a choice of top or rear flue exit.

Vogue stoves can also be placed on one of our ten Stove Benches. Please see page 79 for further information.



Gas Vogue Midi conventional flue, shown with Victorian Corbel mantel

Gas Loft

Product Code	Model	Flue Type	Logs/ Coals	Fuel Type	Heat Input	Heat Output	Efficiency	Energy Efficiency Class
⊗ 548-006	Loft	Conventional	Logs	Nat.Gas	6.20kW	4.40kW	78%	D
⊗ 548-443	Loft	Conventional	Logs	LPG	5.90kW	4.20kW	78%	D
⊗ 548-032	Loft	Balanced	Logs	Nat.Gas	5.30kW	4.50kW	94.3%	A
⊗ 548-457	Loft	Balanced	Logs	LPG	4.80kW	4.20kW	94.3%	A

Gas Loft Dimensions mm (see letters on diagram)

	A	B	C	D	E	F
Loft	770	481	379	CF:600 / BF:592	406	CF:139 / BF:137
Loft with Plinth	815	481	379	CF:646 / BF:638	406	CF:139 / BF:137
Loft with Top Section	1412	481	379	CF:600 / BF:592	406	CF:139 / BF:137
Loft with Plinth & Top Section	1457	481	379	CF:646 / BF:638	406	CF:139 / BF:137
Loft with Log Store	1152	481	379	CF:982 / BF:974	406	CF:139 / BF:137
Loft with Log Store & Top Section	1793	481	379	CF:982 / BF:974	406	CF:139 / BF:137
Loft Wall Mounted	770	481	399	BF:592	406	BF:137
Loft Wall Mounted & Top Section	1412	480	399	BF:592	406	BF:137

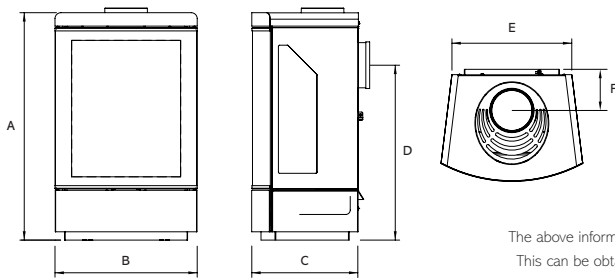

The above information is to assist in your choice of a suitable Gazco stove. This is not intended to be all the information required to install your stove. This can be obtained from your local Gazco retailer or you can download the full installation instructions from the Gazco website at www.gazco.com

Plinth & Base Choice (Required)

948-191	Loft - Wall Mounting Kit
948-016	Loft Plinth - Steel Graphite
948-030	Loft Log Store - Steel Graphite
948-041	Loft Tall Top CF / BF - Steel Graphite
948-077	Loft Plinth - Woodgrain Sandstone
948-102	Loft Plinth - Castillo Sandstone
948-083	Loft Log Store - Woodgrain Sandstone
948-110	Loft Log Store - Castillo Sandstone

Accessories

999-620	Remote System Mains Adaptor
---------	-----------------------------

Stove Flue Pipes

Balanced flue versions of the Loft must only use the 6" stainless steel flue provided. For additional Matt Black enamelled flue collars, please see the Gazco Stoves price list. Gazco recommends the use of 5" matt black enamelled stove pipe with the conventional flue version of the Loft. The components usually required are:

Description	Product Code
1' Straight pipe	4500
2' Straight pipe	4501
3' Straight pipe	4502
90° Long 'elbow' adaptor (9" projection)	4514
Flue collar	8549

Loft stoves can also be placed on one of our ten Stove Benches. Please see page 79 for further information.



Loft with Woodgrain Sandstone Log Store



Gas & Electric Vision

Product Code	Model	CF/BF	Fuel Effect	Lining	Fuel Type	Flue Exit	Heat Input (kW)	Heat Output (kW)	Efficiency	Energy Efficiency Class
⊗ 526-013	Small	CF	Logs	Vermiculite	Nat. Gas	Rear	3.30	2.30	76%	E#
⊗ 526-643	Small	CF	Logs	Vermiculite	LPG	Rear	3.20	2.20	76%	E#
⊗ 526-021	Small	CF	Logs	Vermiculite	Nat. Gas	Top	3.30	2.30	76%	E#
⊗ 526-656	Small	CF	Logs	Vermiculite	LPG	Top	3.20	2.20	76%	E#
⊗ 526-046	Small	BF	Logs	Vermiculite	Nat. Gas	Rear	3.20	2.50	85.1%	C#
⊗ 526-405	Small	BF	Logs	Vermiculite	LPG	Rear	3.10	2.40	85.1%	C#

Gas Vision Small - Manual & Upgradeable Remote Options

⊗ 526-065	Midi	CF	Logs	Vermiculite	Nat. Gas	Rear	4.55	3.10	75%	E#
⊗ 526-417	Midi	CF	Logs	Vermiculite	LPG	Rear	4.35	3.00	75%	E#
⊗ 526-077	Midi	CF	Logs	Vermiculite	Nat. Gas	Top	4.55	3.10	75%	E#
⊗ 526-440	Midi	CF	Logs	Vermiculite	LPG	Top	4.35	3.00	75%	E#
⊗ 526-100	Midi	BF	Logs	Vermiculite	Nat. Gas	Rear	4.30	3.70	95.4%	A#
⊗ 526-471	Midi	BF	Logs	Vermiculite	LPG	Rear	4.30	3.80	95.4%	A#
⊗ 526-109	Midi	BF	Logs	Vermiculite	Nat. Gas	Top	4.30	3.70	95.4%	A#
⊗ 526-486	Midi	BF	Logs	Vermiculite	LPG	Top	4.30	3.80	95.4%	A#

Gas Vision Midi - Manual & Upgradeable Remote Options

⊗ 526-122	Medium	CF	Logs	Vermiculite	Nat. Gas	Rear	6.60	4.60	78%	E#
⊗ 526-515	Medium	CF	Logs	Vermiculite	LPG	Rear	6.70	4.80	78%	E#
⊗ 526-137	Medium	CF	Logs	Vermiculite	Nat. Gas	Top	6.60	4.60	78%	E#
⊗ 526-539	Medium	CF	Logs	Vermiculite	LPG	Top	6.70	4.80	78%	E#
⊗ 526-155	Medium	BF	Logs	Vermiculite	Nat. Gas	Rear	6.60	5.40	90.8%	B#
⊗ 526-580	Medium	BF	Logs	Vermiculite	LPG	Rear	6.60	5.50	90.8%	B#
⊗ 526-176	Medium	BF	Logs	Vermiculite	Nat. Gas	Top	6.60	5.40	90.8%	B#
⊗ 526-612	Medium	BF	Logs	Vermiculite	LPG	Top	6.60	5.50	90.8%	B#

Gas Vision Medium - Manual & Upgradeable Remote Options

⊗ 526-319	Large	CF	Logs	Black Glass	Nat. Gas	Top	6.30	4.10	72%	E
⊗ 526-606	Large	CF	Logs	Black Glass	LPG	Top	6.90	4.60	72%	E
⊗ 526-308	Large	CF	Peb & Stone	Black Glass	Nat. Gas	Top	6.30	4.10	72%	E
⊗ 526-690	Large	CF	Peb & Stone	Black Glass	LPG	Top	6.90	4.60	72%	E
⊗ 526-048	Large	CF	Driftwood	Black Glass	Nat. Gas	Top	6.30	4.10	72%	E
⊗ 526-583	Large	CF	Driftwood	Black Glass	LPG	Top	6.90	4.60	72%	E
⊗ 526-333	Large	BF	Logs	Black Glass	Nat. Gas	Top	6.30	5.20	92%	A
⊗ 526-610	Large	BF	Logs	Black Glass	LPG	Top	6.30	5.30	92%	A
⊗ 526-382	Large	BF	Peb & Stone	Black Glass	Nat. Gas	Top	6.30	5.20	92%	A
⊗ 526-717	Large	BF	Peb & Stone	Black Glass	LPG	Top	6.30	5.30	92%	A
⊗ 526-054	Large	BF	Driftwood	Black Glass	Nat. Gas	Top	6.30	5.20	92%	A
⊗ 526-505	Large	BF	Driftwood	Black Glass	LPG	Top	6.30	5.30	92%	A

Gas Vision Large - Thermostatic Control (Top exit only)

923-010	Large Vision Conventional Flue - Vermiculite Lining Set									
923-433	Large Vision Balanced Flue - Vermiculite Lining Set									
923-517	Large Vision Conventional Flue - Black Reeded Lining Set									
923-607	Large Vision Balanced Flue - Black Reeded Lining Set									

Gas Vision Large - Additional Lining Sets

⊗ 634-680	Small	-	Logs	-	Electric	-	-	2.00	99%	-
⊗ 634-733	Midi	-	Logs	-	Electric	-	-	2.00	99%	-
⊗ 634-795	Medium	-	Logs	-	Electric	-	-	2.00	99%	-

When upgraded with a Programmable Thermostatic Control (8456)

Gas Vision - Accessories

8455	Standard Upgradeable Remote Control for Vision Small, Midi & Medium
8456	Programmable Thermostatic Upgradeable Remote for Vision Small, Midi & Medium
999-620	Thermostatic system mains adaptor for Vision Large only

Stove Flue Pipe

Balanced flue versions of the Gas Visions must only use the 6" stainless steel or anthracite flue pipe. For the conventional flue version of the Gas Vision Gazco recommends the use of 5" matt black or gloss enamelled stove pipe. The components usually required are:

Matt Black Flue Pipe	Product Code
1' Straight pipe	4500
2' Straight pipe	4501
3' Straight pipe	4502
90° Long 'elbow' adaptor (9" projection)	4514
Flue collar	8549

Gloss Flue Pipe	Product Code
1' Straight pipe	4500GB
2' Straight pipe	4501GB
3' Straight pipe	4502GB
135° Bend	4512GB

Recommended clearances between stove and other surfaces: top 9" (225mm), sides 6" (150mm) and rear 2" (50mm). The Gas Vision Large has a top flue exit only.

The Gas Vision stoves can also be placed on one of our ten Stove Benches. Please see page 79 for further information.

Gas Vision Small, Midi & Medium Dimensions

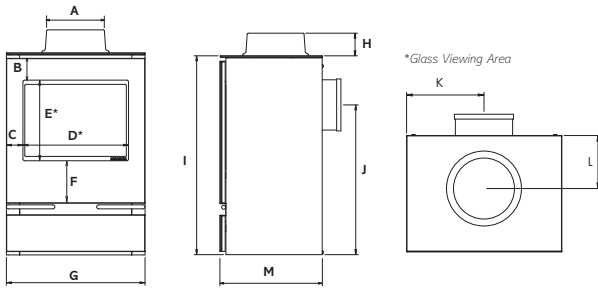

Gas Vision Small, Midi & Medium Dimensions (see letters on diagram)

All sizes in mm	A	B	C	D	E	F	G	H	I	J	K	L	M
Small CF	143	57	58	254	240	122	370	43	529	359	185	97	289
Small BF†	N/A	57	58	254	240	122	370	N/A	529	379	185	N/A	289
Midi CF	143	65	50	316	241	127	415	43	605	436	208	96	311
Midi BF	173	65	50	316	241	127	415	69	605	456	208	142	311
Medium CF	143	77	64	408	274	150	535	43	677	487	268	100	353
Medium BF	173	77	64	408	274	150	535	69	677	538	268	139	353

† Vision Small Balanced flue is rear flue exit only

Electric Vision Dimensions (see letters on diagram)

All sizes in mm	A	B	C	D	E	F	G	H	I	J	K	L	M
Small	N/A	57	58	254	240	122	370	N/A	555	N/A	N/A	N/A	299
Midi	N/A	65	50	316	241	127	415	N/A	604	N/A	N/A	N/A	320
Medium	N/A	77	64	408	274	152	535	N/A	676	N/A	N/A	N/A	363

Gas Vision Large Dimensions

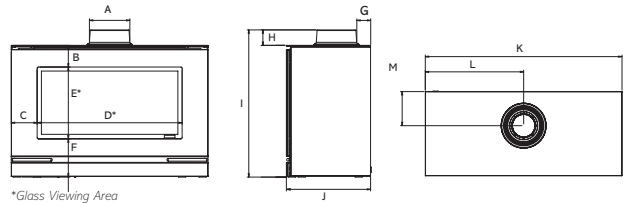

Gas Vision Large Dimensions (see letters on diagram)

All sizes in mm	A	B	C	D	E	F	G	H	I	J	K	L	M
Large CF	144	96	115	646	320	172	66	43	631	390	876	438	140
Large BF	173	97	115	646	320	171	62	69	656	375	876	438	152

Gas Riva2 F670 Glass & Steel

Gas Riva2 F670 Glass & Steel Dimensions (mm)

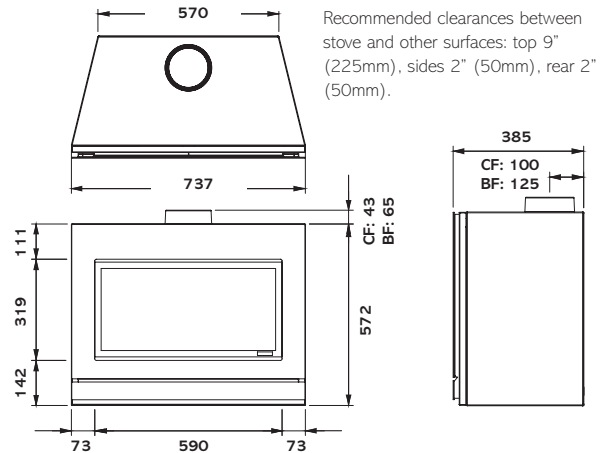

Stove Flue Pipe

Balanced flue versions of the Gas Riva2 F670 Stoves must only use the 6" stainless steel or anthracite flue pipe. For the conventional flue version of the Gas Riva2 F670 Gazco recommends the use of 5" matt black or gloss enamelled stove pipe. The components usually required are:

Matt Black Flue Pipe

	Product Code
1' Straight pipe	4500
2' Straight pipe	4501
3' Straight pipe	4502
90° Long 'elbow' adaptor (9" projection)	4514

Gloss Flue Pipe

	Product Code
1' Straight pipe	4500GB
2' Straight pipe	4501GB
3' Straight pipe	4502GB
135° Bend	4512GB

Product Code	Front	CF/BF	Fuel Effect	Lining	Fuel Type	Heat Input (kW)	Heat Output (kW)	Efficiency	Energy Efficiency Class
Gas Riva2 F670 Glass Fronted - Conventional Flue									
526-356	Glass	CF	Logs	Black Glass	Nat. Gas	6.80	4.70	76%	D
526-512	Glass	CF	Logs	Black Glass	LPG	6.70	4.70	76%	D
Gas Riva2 F670 Glass Fronted - Balanced Flue									
526-388	Glass	BF	Logs	Black Glass	Nat. Gas	6.70	4.90	82%	C
526-720	Glass	BF	Logs	Black Glass	LPG	6.80	5.10	82%	C
Gas Riva2 F670 Steel Fronted - Conventional Flue									
526-003	Steel	CF	Logs	Black Glass	Nat. Gas	6.80	4.70	76%	D
526-408	Steel	CF	Logs	Black Glass	LPG	6.70	4.70	76%	D
Gas Riva2 F670 Steel Fronted - Balanced Flue									
526-195	Steel	BF	Logs	Black Glass	Nat. Gas	6.70	4.90	82%	C
526-578	Steel	BF	Logs	Black Glass	LPG	6.80	5.10	82%	C

Gas Riva2 F670 - Accessories

934-096	Riva2 670 Conventional Flue, Black Reeded Lining Set
934-103	Riva2 670 Conventional Flue, Vermiculite Lining Set
934-119	Riva2 670 Conventional Flue, Brick Effect Lining Set
934-127	Riva2 670 Balanced Flue, Black Reeded Lining Set
934-111	Riva2 670 Balanced Flue, Vermiculite Lining Set
934-137	Riva2 670 Balanced Flue, Brick Effect Lining Set
999-620	Remote System Mains Adaptor

The above information is to assist in your choice of a suitable Gazco stove. This is not intended to be all the information required to install your stove. This can be obtained from your local Gazco retailer or you can download the full installation instructions from the Gazco website at www.gazco.com

The Gas Riva2 F670 stoves can also be placed on one of our ten Stove Benches. Please see page 79 for further information.

Studio Freestanding Gas

Studio 1 Freestanding

Product Code	CF/BF	Fuel Effect	Lining	Fuel Type	Heat Input (kW)	Heat Output (kW)	Efficiency	Energy Efficiency Class
⊗ 508-147	Black CF	Logs	Black Glass	Nat. Gas	6.30	4.10	72%	E
⊗ 508-589	Black CF	Logs	Black Glass	LPG	6.90	4.60	72%	E
⊗ 508-199	White CF	Logs	Black Glass	Nat. Gas	6.30	4.10	72%	E
⊗ 508-606	White CF	Logs	Black Glass	LPG	6.90	4.60	72%	E

Studio 1 Freestanding - Log Effect, Balanced Flue

⊗ 508-248	Black BF	Logs	Black Glass	Nat. Gas	6.30	5.20	92%	A
⊗ 508-597	Black BF	Logs	Black Glass	LPG	6.30	5.30	92%	A
⊗ 508-151	White BF	Logs	Black Glass	Nat. Gas	6.30	5.20	92%	A
⊗ 508-488	White BF	Logs	Black Glass	LPG	6.30	5.30	92%	A

Studio 1 Freestanding - Pebble & Stone, Conventional Flue

⊗ 508-077	Black CF	Peb & Stone	Black Glass	Nat. Gas	6.30	4.10	72%	E
⊗ 508-517	Black CF	Peb & Stone	Black Glass	LPG	6.90	4.60	72%	E
⊗ 508-366	White CF	Peb & Stone	Black Glass	Nat. Gas	6.30	4.10	72%	E
⊗ 508-615	White CF	Peb & Stone	Black Glass	LPG	6.90	4.60	72%	E

Studio 1 Freestanding - Pebble & Stone, Balanced Flue

⊗ 508-396	Black BF	Peb & Stone	Black Glass	Nat. Gas	6.30	5.20	92%	A
⊗ 508-699	Black BF	Peb & Stone	Black Glass	LPG	6.30	5.30	92%	A
⊗ 508-175	White BF	Peb & Stone	Black Glass	Nat. Gas	6.30	5.20	92%	A
⊗ 508-510	White BF	Peb & Stone	Black Glass	LPG	6.30	5.30	92%	A

Studio 1 Freestanding - Driftwood, Conventional Flue

⊗ 508-045	Black CF	Driftwood	Black Glass	Nat. Gas	6.30	4.10	72%	E
⊗ 508-440	Black CF	Driftwood	Black Glass	LPG	6.90	4.60	72%	E
⊗ 508-066	White CF	Driftwood	Black Glass	Nat. Gas	6.30	4.10	72%	E
⊗ 508-479	White CF	Driftwood	Black Glass	LPG	6.90	4.60	72%	E

Studio 1 Freestanding - Driftwood, Balanced Flue

⊗ 508-057	Black BF	Driftwood	Black Glass	Nat. Gas	6.30	5.20	92%	A
⊗ 508-465	Black BF	Driftwood	Black Glass	LPG	6.30	5.30	92%	A
⊗ 508-117	White BF	Driftwood	Black Glass	Nat. Gas	6.30	5.20	92%	A
⊗ 508-502	White BF	Driftwood	Black Glass	LPG	6.30	5.30	92%	A

Additional Lining Sets

923-010	Studio 1 Conventional Flue - Vermiculite Lining Set
923-517	Studio 1 Conventional Flue - Black Reeded Lining Set
923-433	Studio 1 Balanced Flue - Vermiculite Lining Set
923-607	Studio 1 Balanced Flue - Black Reeded Lining Set

Plinth & Bench Mounting Choice (Required)

999-022	Studio 1 Freestanding Plinth - Black
999-035	Studio 1 Freestanding Plinth - White
999-101	Studio 1 Freestanding Bench - Black
999-114	Studio 1 Freestanding Bench - White

Accessories

999-620	Remote System Mains Adaptor
---------	-----------------------------



Studio 2 Freestanding conventional flue with Black front and matching bench, Pebble & Stone fuel bed and optional Vermiculite lining

Studio 2 Freestanding

Product Code	CF/BF	Fuel Effect	Lining	Fuel Type	Heat Input (kW)	Heat Output (kW)	Efficiency	Energy Efficiency Class
⊗ 508-094	Black CF	Logs	Black Glass	Nat. Gas	8.50	6.90	81%	C
⊗ 508-426	Black CF	Logs	Black Glass	LPG	8.50	6.90	81%	C
⊗ 508-187	White CF	Logs	Black Glass	Nat. Gas	8.50	6.90	81%	C
⊗ 508-418	White CF	Logs	Black Glass	LPG	8.50	6.90	81%	C

Studio 2 Freestanding - Log Effect, Balanced Flue

⊗ 508-027	Black BF	Logs	Black Glass	Nat. Gas	8.50	7.00	92%	A
⊗ 508-444	Black BF	Logs	Black Glass	LPG	8.00	6.80	92%	A
⊗ 508-102	White BF	Logs	Black Glass	Nat. Gas	8.50	7.00	92%	A
⊗ 508-640	White BF	Logs	Black Glass	LPG	8.00	6.80	92%	A

Studio 2 Freestanding - Pebble & Stone, Conventional Flue

⊗ 508-207	Black CF	Peb & Stone	Black Glass	Nat. Gas	8.50	6.80	81%	C
⊗ 508-651	Black CF	Peb & Stone	Black Glass	LPG	8.50	6.80	81%	C
⊗ 508-282	White CF	Peb & Stone	Black Glass	Nat. Gas	8.50	6.80	81%	C
⊗ 508-750	White CF	Peb & Stone	Black Glass	LPG	8.50	6.80	81%	C

Studio 2 Freestanding - Pebble & Stone, Balanced Flue

⊗ 508-033	Black BF	Peb & Stone	Black Glass	Nat. Gas	8.50	7.00	92%	A
⊗ 508-527	Black BF	Peb & Stone	Black Glass	LPG	8.00	6.80	92%	A
⊗ 508-322	White BF	Peb & Stone	Black Glass	Nat. Gas	8.50	7.00	92%	A
⊗ 508-508	White BF	Peb & Stone	Black Glass	LPG	8.00	6.80	92%	A

Studio 2 Freestanding - Driftwood, Conventional Flue

⊗ 508-201	Black CF	Driftwood	Black Glass	Nat. Gas	8.50	6.80	81%	C
⊗ 508-498	Black CF	Driftwood	Black Glass	LPG	8.50	6.80	81%	C
⊗ 508-303	White CF	Driftwood	Black Glass	Nat. Gas	8.50	6.80	81%	C
⊗ 508-581	White CF	Driftwood	Black Glass	LPG	8.50	6.80	81%	C

Studio 2 Freestanding - Driftwood, Balanced Flue

⊗ 508-171	Black BF	Driftwood	Black Glass	Nat. Gas	8.50	7.00	92%	A
⊗ 508-562	Black BF	Driftwood	Black Glass	LPG	8.00	6.80	92%	A
⊗ 508-382	White BF	Driftwood	Black Glass	Nat. Gas	8.50	7.00	92%	A
⊗ 508-655	White BF	Driftwood	Black Glass	LPG	8.00	6.80	92%	A

Additional Lining Sets

923-337	Studio 2 Conventional Flue - Vermiculite Lining Set
923-744	Studio 2 Conventional Flue - Black Reeded Lining Set
923-938	Studio 2 Balanced Flue - Vermiculite Lining Set
923-476	Studio 2 Balanced Flue - Black Reeded Lining Set

Plinth & Bench Mounting Choice (Required)

999-048	Studio 2 Freestanding Plinth - Black
999-087	Studio 2 Freestanding Plinth - White
999-127	Studio 2 Freestanding Bench - Black
999-166	Studio 2 Freestanding Bench - White

Accessories

999-620	Remote System Mains Adaptor
---------	-----------------------------

Studio Freestanding Gas Dimensions (mm)

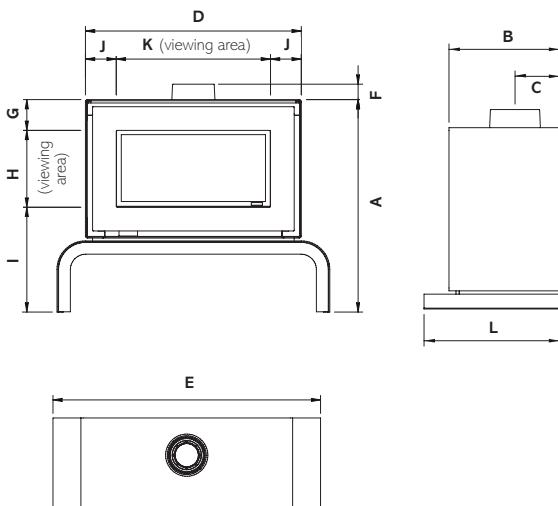

All sizes in mm

	A	B	C	D	E	F	G	H	I	J	K	L
Studio 1 Freestanding on Bench	896	396	CF: 148 BF: 160	910	1150	CF: 43 BF: 65	130	324	442	130	650	-
Studio 2 Freestanding on Bench	896	396	CF: 148 BF: 160	1110	1350	CF: 43 BF: 65	130	324	442	130	850	-
Studio 1 Freestanding on Plinth	649	396	CF: 148 BF: 160	910	1105	CF: 43 BF: 65	130	324	195	130	650	485
Studio 2 Freestanding on Plinth	649	396	CF: 148 BF: 160	1110	1305	CF: 43 BF: 65	130	324	195	130	850	485

Recommended clearances between stove and other surfaces: top 9" (225mm), sides 6" (150mm), rear 2" (50mm).

The above information is to assist in your choice of a suitable Gazco stove. This is not intended to be all the information required to install your stove. This can be obtained from your local Gazco retailer or you can download the full installation instructions from the Gazco website at www.gazco.com

Balanced Flue Gas Stove Systems

The Gazco Balanced Flue system means no chimney is not a problem if you opt for a balanced flue gas stove, as it draws combustion air from outside through its concentric pipe systems. A full range of optional flue components is available to suit configurations shown on page 66.

Gazco have specifically developed a range of flue system components to complement your balanced flue stove. Crafted from 304 grade stainless steel and aluminium with some items additionally offered in anthracite and matt ivory paint finishes. Designed with ease of installation and flexibility in mind, these flue systems simply push together without the requirement for locking bands or screws. Both the inner and outer pipes are secured with easy fit, self locking, high temperature silicone seals. For further information, please speak to your retailer or visit www.gazco.com.



Components for Balanced Flue Models

Basic Stainless Steel Kits	Product Code
Rear exit, horizontal - complete with terminal guard	8526
Top exit, up & out, stoves	8523
Top exit, up & out, Vision Large & F67	8534
Top exit, up & out, Vision Medium	8509
Top exit, vertical	8524
45° offset bend (set of two) for use with 8524	8530
Top exit vertical, Huntingdon 30, Stockton 5, Vision Midi & Vogue	999-539

Basic Anthracite Steel Kits*	Product Code
Top exit, up & out, stoves	8523AN
Top exit, up & out, Vision Large	8534AN
Top exit, up & out, Vision Medium & F670	8509AN
Top exit, vertical	8524AN
45° offset bend (set of two) for use with 8524AN	8530AN
Top exit vertical, Huntingdon 30, Stockton 5, Vision Midi & Vogue	999-539AN

Basic Matt Ivory Steel Kits*	Product Code
Top exit, up & out, stoves	999-111
Top exit, vertical	999-301
Top exit vertical, Huntingdon 30 & Stockton 5	999-224
45° offset bend (set of two) for use with 999-301	999-148

Additional Stainless Steel components for top exit (as required)	Product Code
200mm straight (effective length 140mm)	8527
500mm straight (effective length 440mm)	8528
1000mm straight (effective length 940mm)	8529
364-554mm adjustable straight	999-062
15° bend	999-003
30° bend	999-016
45° bend	8507
90° bend	8508
Horizontal flue terminal (wall)	999-105
Vertical flue terminal (roof)	999-141
Fixed wall support	999-072
Adjustable wall support	999-130
External wall finishing plate	999-235

Additional Matt Ivory Steel components for top exit (as required)	Product Code
200mm straight (effective length 140mm)	999-357
500mm straight (effective length 440mm)	999-372
1000mm straight (effective length 940mm)	999-391
15° bend	999-051
30° bend	999-067
45° bend	999-172
90° bend	999-284

Terminal Guards	Product code
Rear exit	999-159
Horizontal exit	999-201

Aquaseal Flashings	Product code
125-175mm Aluminium Base EPDM Black to 115°C	FXQ-052
150-300mm Aluminium Base EPDM Black to 115°C	FXQ-053
150-200mm Lead Base EPDM Black to 115°C	FXQ-054
150-250mm Sq Section EPDM Black to 115°C	FXQ-058
150-250mm Sq Section/Metal EPDM Black to 115°C	FXQ-059
EPDM Flashing Fixing Kit	FXQ-059SK

Lead Flashings	Product code
Flat Lead Flashing	999-154
30-40 Degree Lead Flashing	999-161
40-50 Degree Lead Flashing	999-174
45-50 Degree Lead Flashing	999-182
45-50 Degree Ridge Flashing	999-193

Additional Components	Product code
Roof Support Balanced Flue	999-032
Fire Stop Balanced Flue	999-040
Storm Collar Balanced Flue	999-046R

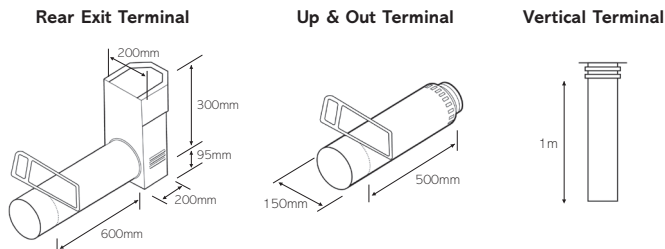

Additional Cast Iron components for top exit	Product Code
Flue collar, Matt Black	8548
Flue collar, Midnight Blue	8548MB
Flue collar, Laurel Green	8548LG
Flue collar, Ivory	8548IV
Flue collar, Matt Ivory	999-433

Additional Anthracite Steel components for top exit (as required)	Product Code
200mm straight (effective length 140mm)	8527AN
500mm straight (effective length 440mm)	8528AN
1000mm straight (effective length 940mm)	8529AN
15° bend	999-031
30° bend	999-078
45° bend	8507AN
90° bend	8508AN

*Note: Terminal lengths are stainless steel.

The above information is to assist in your choice of a suitable Gazco stove. This is not intended to be all the information required to install your stove.

This can be obtained from your local Gazco retailer or you can download the full installation instructions from the Gazco website at www.gazco.com.

Stove Benches

These versatile steel benches are compatible with the Gas Loft, Gas and Electric Vision, Gas Riva2 F670 and Vogue Stoves. With five widths and two heights, they offer greater design possibilities to accommodate your individual styling requirements.

Design Features

- Sturdy steel construction
- Choice of five widths and two heights
- Durable matt black finish
- Proportioned 60mm wide legs
- Allows for central or offset stove positioning

Product Code	Product	W (mm)	H (mm)	D (mm)
RVACLB45BHT	45 Low bench	450	250	420
RVACB45BHT	45 High bench	450	350	420
RVACLB100BHT	100 Low bench	1000	250	420
RVACB100BHT	100 High bench	1000	350	420
RVACLB120BHT	120 Low bench	1200	250	420
RVACB120BHT	120 High bench	1200	350	420
RVACLB140BHT	140 Low bench	1400	250	420
RVACB140BHT	140 High bench	1400	350	420
RVACLB180BHT	180 Low bench	1800	250	465
RVACB180BHT	180 High bench	1800	350	465



Gazco is a member of the Stovax Group which manufactures and distributes many other high quality fireplace products:



Gazco gratefully acknowledges the assistance of the following companies with photographic settings:

www.amara.com; www.furniturevillage.co.uk; www.lauraashley.com; www.faginsantiques.com; www.theorangetree.co.uk; www.habitat.co.uk; www.houseoffraser.co.uk; www.ashorejewellery.co.uk; www.eclectique.co.uk; www.debenhams.com; www.next.co.uk; www.mokodirect.co.uk; www.marksandspencer.com; www.rocketsttstgeorge.co.uk; www.frenchconnection.com; www.wayfair.co.uk; www.urbanoutfitters.com/uk; www.tkmaxx.com; www.homesense.com; www.johnlewis.com; www.coxandcox.co.uk; www.urbanara.co.uk; www.stovax.com; www.farmington.co.uk; www.bnsp.co.uk; www.grandisson.com; www.rudloe-stone.com; www.beechbros.co.uk; www.originalstyle.com; www.heavitreeradio.co.uk; www.stbridgetnurseries.co.uk; www.easyart.com; www.woofenden.com; www.amtico.com; www.opiesuk.co.uk; www.graceandgloryhome.co.uk; www.chunkymonkeyfurniture.co.uk; www.wallsandfloors.co.uk



Gas Huntingdon 30 with tracery door and log-effect in Ivory enamel



To view & download our complete range of brochures, simply scan this code or visit www.gazco.com

Gazco Limited

Osprey Road, Sowton Industrial Estate, Exeter, Devon, England EX2 7JG
 Tel: 01392 261999 Fax: 01392 444148
 E-mail: info@gazco.com • www.gazco.com



A member of the Stovax Group

Find Your Retailer

You can find your nearest retailer by visiting www.gazco.com/find-a-retailer



Your Gazco stockist:	£3.00
	