



CELSI 
...the future of fire



PREMIUM ELECTRIC FIRES COLLECTION 2021/22





WELCOME TO CELSI

At Celsi we know how important it is to create a stylish and relaxing living environment. That's why we've developed this collection of premium electric fires.

I believe our success stems from a combination of innovative design, investment in technology and the highest quality manufacturing standards. As a result all Celsi fires carry a 2 or 5 year guarantee* to reflect my belief in their quality and durability.

This brochure has been designed to make the purchase of your new Celsi heater as simple as possible. I hope you find it both informative and inspiring.



ADVANCED FEATURES



THERMOSTATIC HEATING

Pre-set your heat comfort level for automatic temperature control via the handset.



TIMER FUNCTION

Programmable 7-day heating timer function with hourly on/off control. Up to 8 hrs sleep timer facility available on some models.



LED EFFICIENCY

From controllable flame picture and fuel bed brightness, to colour changing mood lighting, our onboard LED's ensure effective energy saving low power consumption.



ISOFLAME

Independent flame effect capable of displaying in isolation when no heat is required from the appliance.



FLAME FUSION

Captivating Indigo blue flame feature creates a colourful impression by fusing soft and natural yellow flames with an attractive flare of blue flame intensity.



COLOUR CYCLE

Fix your favourite or go dynamic as you cycle through an array of impressive colour changing fuel bed options.



MOOD LIGHTS

Designed to enhance your experience with an ambient stream of colour rich soft LED lighting. Select from a choice of colours to compliment both warm and cool home interiors, or simply to suit your mood.



ECODESIGN COMPLIANT

Integrated design features for optimal energy saving performance and assurance.



We are confident you are getting a product that is built to last. That's why we offer a 2 Year Guarantee across our electric fires range, with an extended guarantee to 5* years on selected Celsi models.

There is no more versatile fuel for home heating than electricity

With a range that includes beautifully crafted electric suites, feature fireplace wall models, classically styled hearth inset fires, and contemporary stove designs, there is a Celsi fire to suit any home.

Best of all you are free to enjoy any of these fantastic heating appliances in any room in your home simply by plugging into the nearest mains socket.

To learn more about the features and benefits of owning a Celsi electric fire please sit back and take a few moments to look through our Advanced Features section, along with our technology introduction to assist you in choosing your perfect Celsi fire experience.



SUITES - E-VR Volare 1100



STOVES - E-VR Rochester



WALL FIRES - U-VR Vichy Satin Champagne



HEARTH FIRES - U-VR Camber Satin Silver

ELECTRIFLAME®VR & ELECTRISTOVE®VR

Virtual Reality – Advanced Flame Projection



View our latest range of Electrifiame VR '3-Sided Glass Fires and Suites' for superior flame aesthetics. This latest patented design raises the appearance and functionality of electric fires to a new level.

Conventional electric fires feature flames on a flat screen at the rear of the product, with E-VR Flame Projection Technology we create the flame illusion to the front, the centre, and the rear of the fuel bed. This creates a totally natural log fire effect, within a range of free-standing Suites, wall mounted fires, hearth inset fires, and outset Stoves.

Outset Suites

E-VR Volare 1100 Illumia	6-7
E-VR Media 1100 Illumia	8
E-VR Carino 1100 Illumia	9
E-VR Volare 750 Illumia	10-11
E-VR Media 750 Illumia	12
E-VR Carino 750 Illumia	13
E-VR Gemma 1000 Illumia	14-15
E-VR Orbital 1000 Illumia	16-17

Wall Outset

E-VR 1400	18-19
E-VR 1100	20-21
E-VR 750	22
E-VR Louvre	23
E-VR Basilica	24

Wall Inset

E-VR Commodus	25
E-VR Metz	26
E-VR Vichy	27

Hearth Inset

E-VR Acero	28-29
E-VR Parrilla	30
E-VR Contemporary	31

Outset Stoves

E-VR Rochester	32-33
E-VR Arundel	34
E-VR Luxima	35

ULTIFLAME® VR

Virtual Reality – True Flame Experience



An exceptional range of fires and suites using 'Open' or 'Glass Fronted' Ultiflame VR technology. At the touch of a button these natural log effect fires display an illusion of hot crystal embers and intense flame captivation.

Discover our classic and contemporary styles including luxury Limestone Suites with integrated feature lighting, beautiful wall and hearth inset models, all designed to look sensational and create comfortable controllable warmth.

Outset Suites

U-VR Adour Elite Illumia	36-37
U-VR Orbital 800 Illumia	38
U-VR Vega	39
U-VR Gemma 800 Illumia	40-41
U-VR Adour Aleesia Illumia	42
U-VR Adour Asencio Illumia	43
U-VR Gemma 600 Illumia	44
U-VR Adour Illumia	45
U-VR Canelo Illumia	46
U-VR Elara	47

Inset Limestone Suites

U-VR Parada Elite Illumia	48
U-VR Avignon Elite	49
U-VR Aleesia Illumia	50
U-VR Asencio	51
U-VR Angelo	52
U-VR Boticelli	53
U-VR Pablo	54

Wall Inset

U-VR Elite	55
U-VR Vichy	56
U-VR Metz	57
U-VR Instinct	58
U-VR Evora Asencio & Asencio	59
U-VR Vader Aleesia & Aleesia	60-61
U-VR Celena	62
U-VR Impulse	63

Hearth Inset

U-VR Arcadia	64
U-VR Decadence	65
U-VR Camber	66
U-VR Frontier	67
U-VR Essence	68
U-VR Designer	69
U-VR Endura	70
U-VR Contemporary	71

ELECTRIFLAME®XD & ELECTRISTOVE®XD

Xtra Dimensional – High Definition Fire



Electrifiame XD is a 'Glass Fronted' extra deep fuel effect with high definition 3D flames. The E-XD range features impressive landscape 'hang-on-the-wall' fires framed with natural stone, premier board, and full glass fascia's.

Our hearth inset fires and stoves provide a wide selection of designs that complement both modern and traditional home interiors.

Wall Outset

E-XD Prestige	72-73
E-XD Black Glass	74
E-XD Royal Botticino	75
E-XD Travertine	76
E-XD Piano Black	77

Hearth Inset

E-XD Camber	78
E-XD Decadence	79
E-XD Essence	80
E-XD Arcadia	81
E-XD Signature	82-83
E-XD Daisy	84
E-XD Caress	85
E-XD Bauhaus	86-87

Outset Stoves

Electristove XD Metal 1 & 2	88-89
Electristove XD Glass 1 & 2	90-91

FLAMONIK & ACCENT

Inspired Flame Effect Technologies



Through illusion and LED light technology beautiful flames emerge to provide a range of distinctive electric fire effects that will bewilder and excite.

Wall Outset

Flamonik Rapture	92
Flamonik Enchant	93

Hearth Inset

Accent Traditional	94
Accent Infusion	95

DIMENSIONS

96-103

ELECTRIFLAME VOLARE 1100

E-VR Outset Illumia Suite

Features

- Flame Projection Technology
- 3 sided glass fire
- Dimmable LED surround lighting
- Customisable fuel effect
- Silver birch logs
- Crystal ash embers
- Single or dual colour flame
- LED brightness control
- Thermostatic remote & manual control operation
- Includes wall fixing bracket



Flame Projection Technology



Specification

Suite Dimensions: mm	H-721 x W-1595 x D-406
Heat Output	1.0kW - 2.0kW
Suite Finish Painted	<input type="checkbox"/> Smooth White



Video

ELECTRIFLAME MEDIA 1100

E-VR Outset Illumia Suite



Video



Features

- Flame Projection Technology
- 3 sided glass fire
- Dimmable LED surround lighting
- Media storage
- Customisable fuel effect
- Silver birch logs
- Crystal ash embers
- Single or dual colour flame
- LED brightness control
- Thermostatic remote & manual control operation

Flame Projection Technology



Specification

Suite Dimensions: mm	H-1126 x W-1595 x D-408
Heat Output	1.0kW - 2.0kW
Suite Finish Painted	<input type="checkbox"/> Smooth White

ELECTRIFLAME CARINO 1100

E-VR Outset Illumia Suite



Video



Features

- Flame Projection Technology
- 3 sided glass fire
- Dimmable LED surround lighting
- Customisable fuel effect
- Silver birch logs
- Crystal ash embers
- Single or dual colour flame
- LED brightness control
- Thermostatic remote & manual control operation

Flame Projection Technology



Specification

Suite Dimensions: mm	H-840 x W-1467 x D-370
Heat Output	1.0kW - 2.0kW
Suite Finish Painted	<input type="checkbox"/> Smooth White



ELECTRIFLAME VOLARE 750

E-VR Outset Illumia Suite

Features

- Flame Projection Technology
- 3 sided glass fire
- Dimmable LED surround lighting
- Customisable fuel effect
- Silver birch logs
- Crystal ash embers
- Single or dual colour flame
- LED brightness control
- Thermostatic remote & manual control operation
- Includes wall fixing bracket



Optional Extras

Woodland logs fuel effect



Video

Specification

Suite Dimensions: mm	H-721 x W-1400 x D-406
Heat Output	1.0kW - 2.0kW
Suite Finish Painted	<input type="checkbox"/> Smooth White

ELECTRIFLAME MEDIA 750

E-VR Outset Illumia Suite



Video



Features

- Flame Projection Technology
- 3 sided glass fire
- Dimmable LED surround lighting
- Media storage
- Customisable fuel effect
- Silver birch logs
- Crystal ash embers
- Single or dual colour flame
- LED brightness control
- Thermostatic remote & manual control operation

Optional Extras

Woodland logs fuel effect



Specification

Suite Dimensions: mm	H-1126 x W-1400 x D-408
Heat Output	1.0kW - 2.0kW
Suite Finish Painted	<input type="checkbox"/> Smooth White

ELECTRIFLAME CARINO 750

E-VR Outset Illumia Suite



Video



Features

- Flame Projection Technology
- 3 sided glass fire
- Dimmable LED surround lighting
- Customisable fuel effect
- Silver birch logs
- Crystal ash embers
- Single or dual colour flame
- LED brightness control
- Thermostatic remote & manual control operation

Optional Extras

Woodland logs fuel effect



Specification

Suite Dimensions: mm	H-840 x W-1118 x D-370
Heat Output	1.0kW - 2.0kW
Suite Finish Painted	<input type="checkbox"/> Smooth White

ELECTRIFLAME GEMMA 1000

E-VR Outset Illumia Suite

Features

- Flame Projection Technology
- Glass fronted fire
- Dimmable LED surround lighting
- Customisable fuel effect
- Silver birch logs
- Crystal ash embers
- Single or dual colour flame
- LED brightness control
- Thermostatic remote & manual control operation



Textured Black & White

Smooth White



Textured White

Specification

Suite Dimensions: mm	H-724 x W-1565 x D-360
Heat Output	0.8kW - 1.6kW
Suite Finishes Painted	<input type="checkbox"/> Smooth White <input checked="" type="checkbox"/> Textured White <input type="checkbox"/> Textured Black



Video

ELECTRIFLAME ORBITAL 1000

E-VR Outset Illumia Suite

Features

- Flame Projection Technology
- Glass fronted fire
- Dimmable LED surround lighting
- Customisable fuel effect
- Silver birch logs
- Crystal ash embers
- Single or dual colour flame
- LED brightness control
- Thermostatic remote & manual control operation



Smooth Mist



Smooth Cream



Smooth White

Specification

Suite Dimensions: mm	H-855 x W-1600 x D-360
Heat Output	0.8kW - 1.6kW
Suite Finishes Painted	<input type="checkbox"/> Smooth White <input type="checkbox"/> Smooth Mist <input type="checkbox"/> Smooth Cream



Video



ELECTRIFLAME 1400

E-VR Wall Outset

Features

- Flame Projection Technology
- 3 sided glass fire
- Customisable fuel effect
- Silver birch logs
- Crystal ash embers
- Single or dual colour flame
- LED brightness control
- Thermostatic remote & manual control operation
- Side blanking installation options



THERMO-
STATIC



7 DAY
TIMER



ENERGY
SAVING



ISO
FLAME



FLAME
FUSION

Flame Projection Technology



Video

Specification

Fire Dimensions: mm	H-375 x W-1430 x D-275
Heat Output	1.0kW - 2.0kW

ELECTRIFLAME 1100

E-VR Wall Outset

Features

- Flame Projection Technology
- 3 sided glass fire
- Customisable fuel effect
- Silver birch logs
- Crystal ash embers
- Single or dual colour flame
- LED brightness control
- Thermostatic remote & manual control operation
- Side blanking installation options



Flame Projection Technology



Specification

Fire Dimensions: mm	H-374 x W-1130 x D-275
Heat Output	1.0kW - 2.0kW



Video

ELECTRIFLAME 750

E-VR Wall Outset



Video



Features

- Flame Projection Technology
- 3 sided glass fire
- Customisable fuel effect
- Silver birch logs
- Crystal ash embers
- Single or dual colour flame
- LED brightness control
- Thermostatic remote & manual control operation
- Side blanking installation options

Optional Extras

Woodland logs fuel effect



Specification

Fire Dimensions: mm	H-374 x W-780 x D-275
Heat Output	0.8kW - 1.6kW

ELECTRIFLAME LOUVRE

E-VR Wall Outset



Video



Features

- Flame Projection Technology
- Glass fronted fire
- Customisable fuel effect
- Woodland logs
- Crystal ash embers
- Single or dual colour flame
- LED brightness control
- Thermostatic remote & manual control operation
- Includes wall fixing bracket



Specification

Dimensions: mm	H-519 x W-1102 x D-201
Heat Output	0.8kW - 1.6kW

Finish

Steel Fabricated & Glass Fascia
Dual Finish
Brushed Metallic



ELECTRIFLAME BASILICA

E-VR Wall Outset



Video



Satin Champagne & Black

Features

- Flame Projection Technology
- Glass fronted fire
- Customisable fuel effect
- Silver birch logs
- Crystal ash embers
- Single or dual colour flame
- LED brightness control
- Thermostatic remote & manual control operation
- Includes wall fixing bracket
- Wall inset option



Specification

Dimensions: mm	H-570 x W-1400 x D-90
Heat Output	0.8kW - 1.6kW



Satin Silver & Black

Finishes

Steel Fabricated Fascia
Dual Finished
Brushed Metallic
Black Painted



ELECTRIFLAME COMMODUS

E-VR Wall Inset



Video



Features

- Flame Projection Technology
- Glass fronted fire
- Customisable fuel effect
- Silver birch logs
- Crystal ash embers
- Single or dual colour flame
- LED brightness control
- Thermostatic remote & manual control operation



Specification

Fire Dimensions: mm	H-330 x W-981 x D-169
Heat Output	0.8kW - 1.6kW

Flame Projection Technology



ELECTRIFLAME METZ

E-VR Wall Inset



Video



Features

- Flame Projection Technology
- Glass fronted fire
- Customisable fuel effect
- Silver birch logs
- Crystal ash embers
- Single or dual colour flame
- LED brightness control
- Thermostatic remote & manual control operation



Specification

Dimensions: mm	H-570 x W-1400 x D-24
Heat Output	0.8kW - 1.6kW

Finishes

Steel Fabricated Fascia
Brushed Metallic



ELECTRIFLAME VICHY

E-VR Wall Inset



Video



Satin Champagne

Features

- Flame Projection Technology
- Glass fronted fire
- Customisable fuel effect
- Silver birch logs
- Crystal ash embers
- Single or dual colour flame
- LED brightness control
- Thermostatic remote & manual control operation



Specification

Dimensions: mm	H-523 x W-1653 x D-87
Heat Output	0.8kW - 1.6kW



Satin Silver

Finishes

Steel Fabricated Fascia
Brushed Metallic





Chrome & Black Nickel

ELECTRIFLAME ACERO

E-VR Hearth Inset

Features

- Aspirational 26 inch fascia
- Flame Projection Technology
- Extra wide glass fronted fire
- Customisable fuel effect
- Silver birch logs
- Crystal ash embers
- Single or dual colour flame
- LED brightness control
- Thermostatic remote & manual control operation



THERMO-STATIC



7 DAY TIMER



ENERGY SAVING



ISO FLAME



FLAME FUSION



Chrome & Satin Silver

Flame Projection Technology



Video

Specification

Dimensions: mm	H-655 x W-657 x D-67
Heat Output	0.8kW - 1.6kW
Finishes	<input type="checkbox"/> Chrome & Satin Silver <input type="checkbox"/> Chrome & Black Nickel
Steel Fabricated Fascia	
Dual Finished	
Twin Metallic	

ELECTRIFLAME PARRILLA

E-VR Hearth Inset



Video



Satin Champagne

Features

- Flame Projection Technology
- Extra wide glass fronted fire
- Customisable fuel effect
- Silver birch logs
- Crystal ash embers
- Single or dual colour flame
- LED brightness control
- Thermostatic remote & manual control operation



Satin Silver

Finishes

Steel Fabricated Fascia
Brushed Metallic



ELECTRIFLAME CONTEMPORARY

E-VR Hearth Inset



Video

Features

- Flame Projection Technology
- Extra wide glass fronted fire
- Customisable fuel effect
- Silver birch logs
- Crystal ash embers
- Single or dual colour flame
- LED brightness control
- Thermostatic remote & manual control operation



Satin Champagne

Finishes

Steel Fabricated Fascia
Brushed Metallic

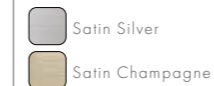

Satin Silver

Specification

Dimensions: mm	H-602 x W-544 x D-90
Heat Output	0.75kW - 1.5kW

Specification

Dimensions: mm	H-602 x W-544 x D-90
Heat Output	0.75kW - 1.5kW

ELECTRISTOVE ROCHESTER

E-VR Outset Stove

Features

- Flame Projection Technology
- Tough steel body
- Curved door design
- Customisable fuel effect
- Silver birch logs
- Crystal ash embers
- Single or dual colour flame
- LED brightness control
- Thermostatic remote & manual control operation



Optional Extras

Woodland logs fuel effect



Specification

Dimensions: mm	H-606 x W-532 x D-372
Heat Output	1.0kW - 2.0kW
Finish	Black
Steel Fabricated Painted	



Video

ELECTRISTOVE ARUNDEL

E-VR Outset Stove



Video



Features

- Flame Projection Technology
- Tough steel body
- Customisable fuel effect
- Silver birch logs
- Crystal ash embers
- Single or dual colour flame
- LED brightness control
- Thermostatic remote & manual control operation



Optional Extras

Woodland logs fuel effect



Finish

Steel Fabricated
Painted



Specification

Dimensions: mm	H-582 x W-430 x D-389
Heat Output	0.75kW - 1.5kW

ELECTRISTOVE LUXIMA

E-VR Outset Stove



Video



Features

- Flame Projection Technology
- Tough steel body
- Customisable fuel effect
- Silver birch logs
- Crystal ash embers
- Single or dual colour flame
- LED brightness control
- Thermostatic remote & manual control operation



Optional Extras

Woodland logs fuel effect



Finish

Steel Fabricated
Painted



Specification

Dimensions: mm	H-595 x W-471 x D-359
Heat Output	0.75kW - 1.5kW

Smooth White



ULTIFLAME ADOUR ELITE

U-VR Outset Illumia Suite

Features

- Open fire experience
- Dimmable LED surround lighting
- Customisable fuel effect
- Silver birch logs
- Crystal ash embers
- Single or dual colour flame
- LED brightness control
- Thermostatic remote & manual control operation



Smooth Mist



Smooth Cream



Video

Specification

Suite Dimensions: mm	H-990 x W-1465 x D-380
Heat Output	0.8kW - 1.6kW
Suite Finishes Painted	<input type="checkbox"/> Smooth White <input type="checkbox"/> Smooth Mist <input type="checkbox"/> Smooth Cream

ULTIFLAME ORBITAL 800

U-VR Outset Illumia Suite



Video



Smooth Mist

Features

- Open fire experience
- Dimmable LED surround lighting
- Customisable fuel effect
- Silver birch logs
- Crystal ash embers
- Single or dual colour flame
- LED brightness control
- Thermostatic remote & manual control operation



Smooth Cream



Smooth White

Suite Finishes

- Painted
- Smooth White
 - Smooth Mist
 - Smooth Cream

Specification

Suite Dimensions: mm	H-850 x W-1466 x D-360
Heat Output	0.8kW - 1.6kW

ULTIFLAME VEGA

U-VR Outset Suite



Video



Smooth White

Features

- Open fire experience
- Customisable fuel effect
- Silver birch logs
- Crystal ash embers
- Single or dual colour flame
- LED brightness control
- Thermostatic remote & manual control operation



Smooth Mist



Smooth Cream

Suite Finishes

- Painted Surround
Black interior
- Smooth White
 - Smooth Mist
 - Smooth Cream

Specification

Suite Dimensions: mm	H-892 x W-1430 x D-330
Heat Output	0.8kW - 1.6kW

ULTIFLAME GEMMA 800

U-VR Outset Illumia Suite

Features

- Open fire experience
- Dimmable LED surround lighting
- Customisable fuel effect
- Silver birch logs
- Crystal ash embers
- Single or dual colour flame
- LED brightness control
- Thermostatic remote & manual control operation



Smooth White



Textured Black & White



Textured White

Specification

Suite Dimensions: mm	H-740 x W-1465 x D-360
Heat Output	0.8kW – 1.6kW
Suite Finish Painted	<input type="checkbox"/> Smooth White <input checked="" type="checkbox"/> Textured White <input type="checkbox"/> Textured Black



Video

ULTIFLAME ADOUR ALEESIA

U-VR Outset Illumia Suite



Video



Features

- Glass Fronted Fire
- Dimmable LED surround lighting
- Customisable fuel effect
- Silver birch logs
- Crystal ash embers
- Single or dual colour flame
- LED brightness control
- Thermostatic remote & manual control operation



Smooth White with Black interior and hearth



Specification

Suite Dimensions: mm	H-990 x W-1465 x D-380
Heat Output	0.8kW - 1.6kW

Suite Finishes

Painted surround
Black interior and
hearth option

Smooth White

ULTIFLAME ADOUR ASENCIO

U-VR Outset Illumia Suite



Video



Features

- Glass Fronted Fire
- Dimmable LED surround lighting
- Customisable fuel effect
- Silver birch logs
- Crystal ash embers
- Single or dual colour flame
- LED brightness control
- Thermostatic remote & manual control operation

Flame Fusion – dual colour



Specification

Suite Dimensions: mm	H-1090 x W-1340 x D-380
Heat Output	0.8kW - 1.6kW

Suite Finishes

Painted surround
Black interior and hearth

Smooth White

ULTIFLAME GEMMA 600

U-VR Outset Illumia Suite



Video



Textured White

Features

- Open Fronted Fire
- Dimmable LED surround lighting
- Customisable fuel effect
- Silver birch logs
- Crystal ash embers
- Single or dual colour flame
- LED brightness control
- Thermostatic remote & manual control operation



Smooth White



Textured Black & White

Suite Finishes

Painted

- Smooth White
- Textured White
- Textured Black

Specification

Suite Dimensions: mm	H-835 W-1185 D-360
Heat Output	0.8kW - 1.6kW

ULTIFLAME ADOUR

U-VR Outset Illumia Suite



Video



Smooth White

Features

- Open fire experience
- Dimmable LED surround lighting
- Customisable fuel effect
- Silver birch logs
- Crystal ash embers
- Single or dual colour flame
- LED brightness control
- Thermostatic remote & manual control operation



Smooth Cream



Smooth Mist

Suite Finishes

Painted surround
Black interior and hearth

- Smooth White
- Smooth Mist
- Smooth Cream

Specification

Suite Dimensions: mm	H-1090 x W-1340 x D-380
Heat Output	0.8kW - 1.6kW

ULTIFLAME CANELO

U-VR Outset Illumia Suite



Video



Features

- Open fire experience
- Dimmable LED surround lighting
- Customisable fuel effect
- Silver birch logs
- Crystal ash embers
- Single or dual colour flame
- LED brightness control
- Thermostatic remote & manual control operation



Specification

Suite Dimensions: mm	H-1090 W-1340 D-340
Heat Output	0.8kW - 1.6kW

Suite Finishes

Painted Surround Black interior	<input type="checkbox"/> Smooth White
------------------------------------	---------------------------------------

ULTIFLAME ELARA

U-VR Outset Suite



Video



Features

- Open fire experience
- Customisable fuel effect
- Silver birch logs
- Crystal ash embers
- Single or dual colour flame
- LED brightness control
- Thermostatic remote & manual control operation



Specification

Suite Dimensions: mm	H-892 x W-1228 x D-330
Heat Output	0.8kW - 1.6kW



Smooth Cream



Smooth White

Suite Finishes

Painted Surround Black interior	<input type="checkbox"/> Smooth White
	<input type="checkbox"/> Smooth Mist
	<input type="checkbox"/> Smooth Cream

ULTIFLAME PARADA ELITE

U-VR Inset Limestone Illumia Suite



Video



Features

- Open fire experience
- Dimmable LED surround lighting
- Customisable fuel effect
- Silver birch logs
- Crystal ash embers
- Single or dual colour flame
- LED brightness control
- Thermostatic remote & manual control operation
- Available in two sizes



Specification

Suite Dimensions: mm	54" 58"	H-990 x W-1350 x D-400 H-990 x W-1464 x D-400
Heat Output	0.8kW – 1.6kW	

Suite Finish

Natural Limestone

ULTIFLAME AVIGNON ELITE

U-VR Inset Limestone Suite



Video



Features

- Open fire experience
- Customisable fuel effect
- Silver birch logs
- Crystal ash embers
- Single or dual colour flame
- LED brightness control
- Thermostatic remote & manual control operation
- Available in two sizes



Specification

Suite Dimensions: mm	54" 58"	H-990 x W-1350 x D-380 H-990 x W-1464 x D-380
Heat Output	0.8kW – 1.6kW	

Suite Finish

Natural Limestone

ULTIFLAME ALEESIA

U-VR Inset Limestone Illumia Suite



Video



Features

- Glass Fronted Fire
- Dimmable LED surround lighting
- Customisable fuel effect
- Silver birch logs
- Crystal ash embers
- Single or dual colour flame
- LED brightness control
- Thermostatic remote & manual control operation
- Available in two sizes



Specification

Suite Dimensions: mm	54" 58"	H-1050 x W-1370 x D-400 H-1050 x W-1470 x D-400
Heat Output	0.8kW – 1.6kW	

Suite Finish

Natural Limestone

ULTIFLAME ASENCIO

U-VR Inset Limestone Suite



Video



Features

- Glass Fronted Fire
- Customisable fuel effect
- Silver birch logs
- Crystal ash embers
- Single or dual colour flame
- LED brightness control
- Thermostatic remote & manual control operation



Specification

Suite Dimensions: mm	H-1095 x W-1376 x D-380
Heat Output	0.8kW – 1.6kW

Suite Finish

Natural Limestone

ULTIFLAME ANGELO

U-VR Inset Limestone Suite



Video



Features

- Open fire experience
- Customisable fuel effect
- Silver birch logs
- Crystal ash embers
- Single or dual colour flame
- LED brightness control
- Thermostatic remote & manual control operation



Specification

Suite Dimensions: mm	H-995 x W-1300 x D-380
Heat Output	0.8kW - 1.6kW

Suite Finish

Natural Limestone

ULTIFLAME BOTICELLI

U-VR Inset Limestone Suite



Video



Features

- Open fire experience
- Customisable fuel effect
- Silver birch logs
- Crystal ash embers
- Single or dual colour flame
- LED brightness control
- Thermostatic remote & manual control operation



Specification

Suite Dimensions: mm	H-980 x W-1280 x D-380
Heat Output	0.8kW - 1.6kW

Suite Finish

Natural Limestone

ULTIFLAME PABLO

U-VR Inset Limestone Suite



Video



Features

- Open fire experience
- Customisable fuel effect
- Silver birch logs
- Crystal ash embers
- Single or dual colour flame
- LED brightness control
- Thermostatic remote & manual control operation



Specification

Suite Dimensions: mm	H-980 x W-1220 x D-410
Heat Output	0.8kW - 1.6kW

Suite Finish

Natural Limestone

ULTIFLAME ELITE

U-VR Wall Inset



Video



Features

- Open fire experience
- Customisable fuel effect
- Silver birch logs
- Crystal ash embers
- Single or dual colour flame
- LED brightness control
- Thermostatic remote & manual control operation



Specification

Fire Dimensions: mm	H-352 x W-843 x D-182
Heat Output	0.8kW - 1.6kW

ULTIFLAME VICHY

U-VR Wall Inset



Video



Satin Silver

Features

- Open fire experience
- Customisable fuel effect
- Silver birch logs
- Crystal ash embers
- Single or dual colour flame
- LED brightness control
- Thermostatic remote & manual control operation



Black Textured



Satin Champagne



Specification

Dimensions: mm	H-540 x W-1490 x D-71
Heat Output	0.8kW - 1.6kW

Finishes

- Steel Fabricated Fascia
- Brushed Metallic or Black Textured Paint
- Satin Silver
 - Satin Champagne
 - Black Textured

ULTIFLAME METZ

U-VR Wall Inset



Video



Satin Champagne

Features

- Open fire experience
- Customisable fuel effect
- Silver birch logs
- Crystal ash embers
- Single or dual colour flame
- LED brightness control
- Thermostatic remote & manual control operation



Satin Silver



Specification

Dimensions: mm	H-540 x W-1490 x D-22.5
Heat Output	0.8kW - 1.6kW

Finishes

- Steel Fabricated Fascia
- Brushed Metallic
- Satin Silver
 - Satin Champagne

ULTIFLAME INSTINCT

U-VR Wall Inset



Video



Satin Champagne

Features

- Open fire experience
- Customisable fuel effect
- Silver birch logs
- Crystal ash embers
- Single or dual colour flame
- LED brightness control
- Thermostatic remote & manual control operation



Satin Black



Specification

Dimensions: mm	H-647 x W-1138 x D-60
Heat Output	0.8kW - 1.6kW

Finishes

Steel Fabricated Fascia	Satin Champagne
Steel Fabricated Fascia Brushed Metallic	Satin Black

ULTIFLAME EVORA ASENCIO & ASENCIO

U-VR Wall Inset



Video



Evora Asencio

Features

- Glass fronted fire
- Customisable fuel effect
- Silver birch logs
- Crystal ash embers
- Single or dual colour flame
- LED brightness control
- Thermostatic remote & manual control operation



Asencio trimless installation



Specification

Dimensions: mm	Evora Asencio H-768 x W-762 x D-19 Asencio H-759 x W-670 x D-183
Heat Output	0.8kW - 1.6kW

Finish

Steel Fabricated Fascia Dual Metallic	Black Nickel & Chrome
--	-----------------------

Vader Aleesia Black Nickel & Black



ULTIFLAME VADER ALEESIA & ALEESIA

U-VR Wall Inset

Features

- Glass fronted fire
- Customisable fuel effect
- Silver birch logs
- Crystal ash embers
- Single or dual colour flame
- LED brightness control
- Thermostatic remote & manual control operation



Vader Aleesia Black Nickel & Chrome



Aleesia trimless installation



Video

Specification

Dimensions: mm	Vader Aleesia H-683 x W-963 x D-21 Aleesia H-679 x W-870 x D-183
Heat Output	0.9kW - 1.8kW
Finishes	<div style="display: flex; gap: 10px;"> <div style="width: 15px; height: 15px; background-color: black; border: 1px solid black;"></div> Black Nickel & Black </div> <div style="display: flex; gap: 10px;"> <div style="width: 15px; height: 15px; background-color: black; border: 1px solid black;"></div> Black Nickel & Chrome </div>
Steel Fabricated Fascia	
Dual Metallic	

ULTIFLAME CELENA

U-VR Wall Inset



Video



Features

- Open fire experience
- Customisable fuel effect
- Silver birch logs
- Crystal ash embers
- Single or dual colour flame
- LED brightness control
- Thermostatic remote & manual control operation



Specification

Fire Dimensions: mm	H-447 x W-560 x D-182
Heat Output	0.8kW - 1.6kW

ULTIFLAME IMPULSE

U-VR Wall Inset



Video



Satin Silver

Features

- Open fire experience
- Customisable fuel effect
- Silver birch logs
- Crystal ash embers
- Single or dual colour flame
- LED brightness control
- Thermostatic remote & manual control operation



Specification

Dimensions: mm	H-742 x W-860 x D-60
Heat Output	0.8kW - 1.6kW



Satin Black

Finishes

Steel Fabricated Fascia
Brushed Metallic



ULTIFLAME ARCADIA

U-VR Hearth Inset



Video



Black & Gold

Features

- Open fire experience
- Customisable fuel effect
- Silver birch logs
- Crystal ash embers
- Single or dual colour flame
- LED brightness control
- Thermostatic remote & manual control operation



Optional Extras

75mm Spacer frame
For flat wall installation



Black & Chrome

Finishes

High Quality Cast Iron Fascia
Paint and Metallic Plated



Specification

Dimensions: mm	H-612 x W-528 x D-154
Heat Output	0.75kW - 1.5kW

ULTIFLAME DECADENCE

U-VR Hearth Inset



Video



Chrome

Features

- Open fire experience
- Customisable fuel effect
- Silver birch logs
- Crystal ash embers
- Single or dual colour flame
- LED brightness control
- Thermostatic remote & manual control operation



Optional Extras

75mm Spacer frame
For flat wall installation



Gold

Black Nickel

Specification

Dimensions: mm	H-630 x W-528.5 x D-151
Heat Output	0.75kW - 1.5kW

Finishes

High Quality Cast Iron Fascia
Metallic Plated

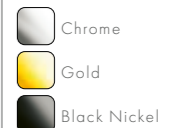

ULTIFLAME CAMBER

U-VR Hearth Inset



Video



Satin Silver

Features

- Open fire experience
- Customisable fuel effect
- Silver birch logs
- Crystal ash embers
- Single or dual colour flame
- LED brightness control
- Thermostatic remote & manual control operation



Optional Extras

75mm Spacer frame
For flat wall installation



Satin Champagne

Black Textured

Finishes

Anodised Aluminium Fascia
Brushed Metallic or
Black Textured Paint

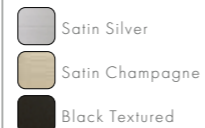

Specification

Dimensions: mm	H-619 x W-537 x D-135
Heat Output	0.75kW - 1.5kW

ULTIFLAME FRONTIER

U-VR Hearth Inset



Video



Features

- Open fire experience
- Customisable fuel effect
- Silver birch logs
- Crystal ash embers
- Single or dual colour flame
- LED brightness control
- Thermostatic remote & manual control operation



Optional Extras

75mm Spacer frame
For flat wall installation

Specification

Dimensions: mm	H-617 x W-541 x D-131
Heat Output	0.75kW - 1.5kW

Finish

Steel Fabricated Fascia
Dual Finish
Paint & Metallic

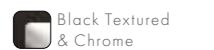

ULTIFLAME ESSENCE

U-VR Hearth Inset



Video



Black

Features

- Open fire experience
- Customisable fuel effect
- Silver birch logs
- Crystal ash embers
- Single or dual colour flame
- LED brightness control
- Thermostatic remote & manual control operation



Optional Extras

75mm Spacer frame
For flat wall installation



Satin Silver

Specification

Dimensions: mm	H-619 x W-537 x D-127
Heat Output	0.75kW - 1.5kW

Finishes

Steel Fabricated Fascia
Brushed Metallic
Smooth Black Paint

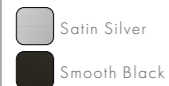

ULTIFLAME DESIGNER

U-VR Hearth Inset



Video



Black Nickel & Chrome

Features

- Open fire experience
- Customisable fuel effect
- Silver birch logs
- Crystal ash embers
- Single or dual colour flame
- LED brightness control
- Thermostatic remote & manual control operation



Optional Extras

75mm Spacer frame
For flat wall installation



Chrome & Black

Specification

Dimensions: mm	H-599 x W-498 x D-129
Heat Output	0.75kW - 1.5kW

Finishes

Steel Fabricated Fascia
Dual Metallic



ULTIFLAME ENDURA

U-VR Hearth Inset



Video



Chrome

Features

- Open fire experience
- Customisable fuel effect
- Silver birch logs
- Crystal ash embers
- Single or dual colour flame
- LED brightness control
- Thermostatic remote & manual control operation



Optional Extras

75mm Spacer frame
For flat wall installation



Black

Finishes

Steel Fabricated Fascia
Metallic or Smooth Black Paint

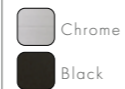

Specification

Dimensions: mm	H-598 x W-497 x D-126
Heat Output	0.75kW - 1.5kW

ULTIFLAME CONTEMPORARY

U-VR Hearth Inset



Video



Satin Silver

Features

- Open fire experience
- Customisable fuel effect
- Silver birch logs
- Crystal ash embers
- Single or dual colour flame
- LED brightness control
- Thermostatic remote & manual control operation



Optional Extras

75mm Spacer frame
For flat wall installation



Satin Champagne

Finishes

Steel Fabricated Fascia
Brushed Metallic

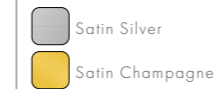

Specification

Dimensions: mm	H-598 x W-493 x D-132
Heat Output	0.75kW - 1.5kW

ELECTRIFLAME PRESTIGE

E-XD Wall Outset

Features

- Glass fronted fire
- High definition effect
- Extra deep 3D coals
- Relaxing smoky flames
- LED brightness control
- Thermostatic remote & manual control operation
- Includes wall fixing bracket



Atmospheric flame ascension



Specification

Dimensions: mm	H-600 x W-1100 x D-150
Heat Output	0.75kW – 1.5kW
Finish	 Prestige Brown
Natural Marble	



Video

ELECTRIFLAME BLACK GLASS

E-XD Wall Outset



Video

Black Glass 1300



Features

- Glass fronted fire
- High definition effect
- Extra deep 3D coals
- Relaxing smoky flames
- LED brightness control
- Thermostatic remote & manual control operation
- Includes wall fixing bracket
- Available in two sizes



Black Glass 1100



Specification

Dimensions: mm	H-600 x W-1300 & 1100 x D-126
Heat Output	0.75kW - 1.5kW

Finish



ELECTRIFLAME ROYAL BOTTICINO

E-XD Wall Outset



Video



Features

- Glass fronted fire
- High definition effect
- Extra deep 3D coals
- Relaxing smoky flames
- LED brightness control
- Thermostatic remote & manual control operation
- Includes wall fixing bracket



Specification

Dimensions: mm	H-600 x W-1100 x D-150
Heat Output	0.75kW - 1.5kW

Finish

Natural Marble



ELECTRIFLAME TRAVERTINE

E-XD Wall Outset



Video

Travertine 1100



Features

- Glass fronted fire
- High definition effect
- Extra deep 3D coals
- Relaxing smoky flames
- LED brightness control
- Thermostatic remote & manual control operation
- Includes wall fixing bracket
- Available in two sizes



Travertine 1300



Specification

Dimensions: mm	H-625 x W-1300 & 1100 x D-150
Heat Output	0.75kW - 1.5kW

Finish

Natural  Travertine

ELECTRIFLAME PIANO BLACK

E-XD Wall Outset



Video



Features

- Glass fronted fire
- High definition effect
- Extra deep 3D coals
- Relaxing smoky flames
- LED brightness control
- Thermostatic remote & manual control operation
- Includes wall fixing bracket



Specification

Dimensions: mm	H-600 x W-1300 x D-150
Heat Output	0.75kW - 1.5kW

Finish

Glossy Painted  Black

ELECTRIFLAME CAMBER

E-XD Hearth Inset



Video



Satin Champagne

Features

- Glass fronted fire
- Customisable fuel effect
- Silver birch logs
- Crystal ash embers
- Single or dual colour flame
- LED brightness control
- Thermostatic remote & manual control operation



Optional Extras

75mm Spacer frame
For flat wall installation



Satin Silver

Black Textured

Finishes

Anodised Aluminium Fascia
Brushed Metallic
Textured Black Paint

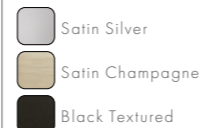

Specification

Dimensions: mm	H-619 x W-537 x D-105
Heat Output	0.75kW - 1.5kW

ELECTRIFLAME DECADENCE

E-XD Hearth Inset



Video



Gold

Features

- Glass fronted fire
- Customisable fuel effect
- Silver birch logs
- Crystal ash embers
- Single or dual colour flame
- LED brightness control
- Thermostatic remote & manual control operation



Optional Extras

75mm Spacer frame
For flat wall installation



Chrome

Black Nickel

Specification

Dimensions: mm	H-630 x W-528.5 x D-122
Heat Output	0.75kW - 1.5kW

Finishes

High Quality Cast Iron Fascia
Metallic Plated

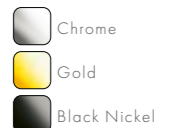

ELECTRIFLAME ESSENCE

E-XD Hearth Inset



Video



Antique Brass

Features

- Glass fronted fire
- Customisable fuel effect
- Silver birch logs
- Crystal ash embers
- Single or dual colour flame
- LED brightness control
- Thermostatic remote & manual control operation



Optional Extras

75mm Spacer frame
For flat wall installation



Satin Silver

Black

Specification

Dimensions: mm	H-610 x W-537 x D-105
Heat Output	0.75kW - 1.5kW

Finishes

Steel Fabricated Fascia
Brushed Metallic
or Smooth Black Paint

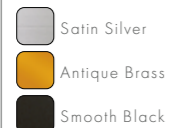

ELECTRIFLAME ARCADIA

E-XD Hearth Inset



Video



Black & Chrome

Features

- Glass fronted fire
- Customisable fuel effect
- Silver birch logs
- Crystal ash embers
- Single or dual colour flame
- LED brightness control
- Thermostatic remote & manual control operation



Optional Extras

75mm Spacer frame
For flat wall installation



Black & Gold

Specification

Dimensions: mm	H-612 x W-528 x D-130
Heat Output	0.75kW - 1.5kW

Finishes

High Quality Cast Iron Fascia
Dual Metallic Plated

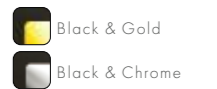

Black Nickel & Black



ELECTRIFLAME SIGNATURE

E-XD Hearth Inset

Features

- Glass fronted fire
- Customisable fuel effect
- Silver birch logs
- Crystal ash embers
- Single or dual colour flame
- LED brightness control
- Thermostatic remote & manual control operation



THERMO-STATIC



7 DAY TIMER



ENERGY SAVING



ISO FLAME



FLAME FUSION

Optional Extras

75mm Spacer frame
For flat wall installation



Satin Silver & Chrome



Video

Specification

Suite Dimensions: mm	H-599 x W-498 x D-129
Heat Output	0.75kW – 1.5kW
Finishes	<input type="checkbox"/> Black Nickel & Black <input type="checkbox"/> Satin Silver & Chrome
Steel Fabricated Fascia	
Dual Metallic	

ELECTRIFLAME DAISY

E-XD Hearth Inset



Video



Satin Silver

Features

- Glass fronted fire
- Customisable fuel effect
- Silver birch logs
- Crystal ash embers
- Single or dual colour flame
- LED brightness control
- Thermostatic remote & manual control operation



Optional Extras

75mm Spacer frame
For flat wall installation



Brass

Black

Finishes

Steel Fabricated Trim
Solid Brass or Cast Iron Fret
Metallic or Smooth Black Paint



Specification

Dimensions: mm	H-595 x W-490 x D-100
Heat Output	0.75kW - 1.5kW

ELECTRIFLAME CARESS

E-XD Hearth Inset



Video



Satin Silver

Features

- Glass fronted fire
- Customisable fuel effect
- Silver birch logs
- Crystal ash embers
- Single or dual colour flame
- LED brightness control
- Thermostatic remote & manual control operation



Optional Extras

75mm Spacer frame
For flat wall installation



Brass

Finishes

Quality Cast Trim and Fret
Solid Brass or Cast Iron
Black paint detail

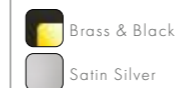

Specification

Dimensions: mm	H-650 x W-535 x D-100
Heat Output	0.75kW - 1.5kW

ELECTRIFLAME BAUHAUS

E-XD Hearth Inset

Features

- Glass fronted fire
- Customisable fuel effect
- Silver birch logs
- Crystal ash embers
- Single or dual colour flame
- LED brightness control
- Thermostatic remote & manual control operation



Optional Extras

75mm Spacer frame
For flat wall installation



Brass

Chrome

Finishes

Steel Fabricated Trim
Solid Brass or Cast Iron Fret
Metallic or Smooth Black Paint

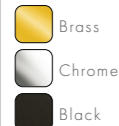

Black

Specification

Dimensions: mm	H-595 x W-490 x D-100
Heat Output	0.75kW - 1.5kW



Video

Metal 2



ELECTRISTOVE METAL 1 & 2

E-XD Outset Stove

Features

- Tough steel body & door
- High definition effect
- Extra deep 3D coals
- Relaxing smoky flames
- LED brightness control
- Thermostatic remote & manual control operation



THERMO-STATIC



7 DAY TIMER



ENERGY SAVING



ISO FLAME



Metal 1



METAL 2
Video

Specification

Dimensions: mm	Metal 1 Metal 2	H-579 x W-430 x D-332 H-587 x W-524 x D-295
Heat Output		1.0kW - 2.0kW
Finish	Steel Fabricated Body	 Black



METAL 1
Video

ELECTRISTOVE GLASS 1 & 2

E-XD Outset Stove

Features

- Tough steel body
- Glass door & stove top
- High definition effect
- Extra deep 3D coals
- Relaxing smoky flames
- LED brightness control
- Thermostatic remote & manual control operation



Glass 2



GLASS 2
Video



Glass 1

Specification

Dimensions: mm	Glass 1 Glass 2	H-583 x W-430 x D-334 H-591 x W-524 x D-295
Heat Output		1.0kW – 2.0kW
Finish	Steel Fabricated Body Glass Door	Black Glass & Chrome



GLASS 1
Video

FLAMONIK RAPTURE

Wall Outset



Video



Features

- Flat glass fascia
- Distinctive flame effect
- Raised log fuel bed
- Thermostatic remote & manual control operation
- Includes wall fixing bracket



Magenta



Blue



Amber



Specification

Dimensions: mm	H-440 x W-686 x D-110
Heat Output	0.75kW - 1.5kW

Finish



Black Glass

FLAMONIK ENCHANT

Wall Outset



Video



Features

- Curved glass fascia
- Enchanting smoky flame effect
- Raised log fuel bed
- Thermostatic remote & manual control operation
- Includes wall fixing bracket



Magenta



Blue



Amber



Specification

Dimensions: mm	H-441 x W-916 x D-126
Heat Output	0.75kW - 1.5kW

Finish



Black Glass

ACCENT TRADITIONAL

Hearth Inset



Video



Brass

Features

- Open fire experience
- Lively ribbon flame effect
- Coal effect fuel bed
- LED brightness control
- Thermostatic remote & manual control operation



Chrome

Finishes

Steel Fabricated
Metallic Plated Trim

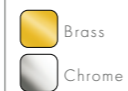

Specification

Dimensions: mm	H-595 x W-490 x D-35
Heat Output	1.0kW - 2.0kW

ACCENT INFUSION

Hearth Inset



Video



Chrome & Satin Silver

Features

- Open fire experience
- Lively ribbon flame effect
- Coal effect fuel bed
- LED brightness control
- Thermostatic remote & manual control operation



Brass & Black



Black & Chrome

Finishes

Steel Fabricated Fascia
Dual Metallic & Painted

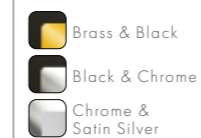

Specification

Dimensions: mm	H-595 x W-498x D-83
Heat Output	1.0kW - 2.0kW

ELECTRIFLAME® VR

Outset Suites - 6-15

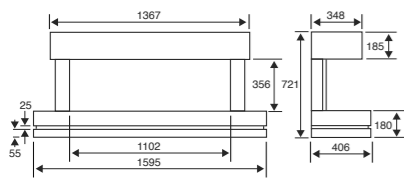

VOLARE 1100 ILLUMIA

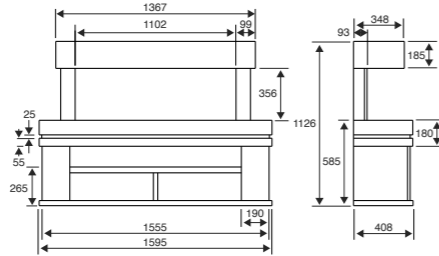

MEDIA 1100 ILLUMIA

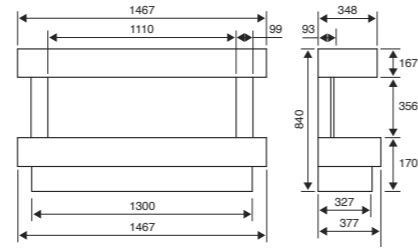

CARINO 1100 ILLUMIA

Wall Inset - 23-25

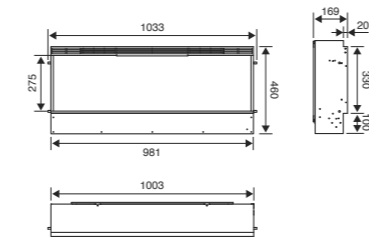

COMMODUS

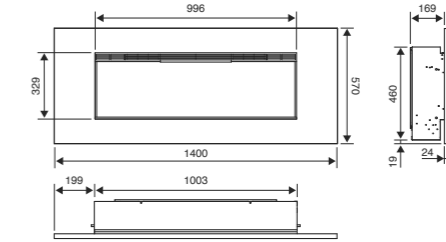

METZ

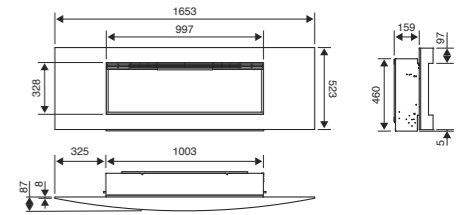

VICHY

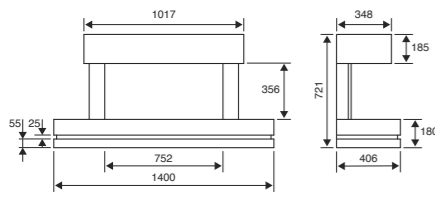

VOLARE 750 ILLUMIA

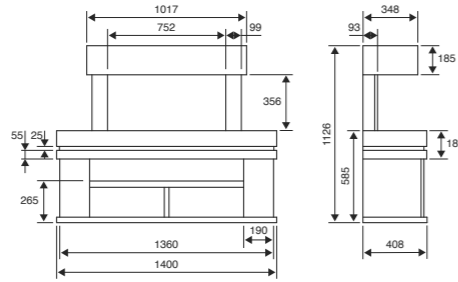

MEDIA 750 ILLUMIA

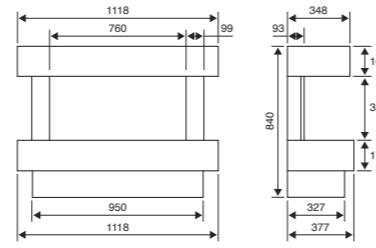

CARINO 750 ILLUMIA

Hearth Inset - 26-29

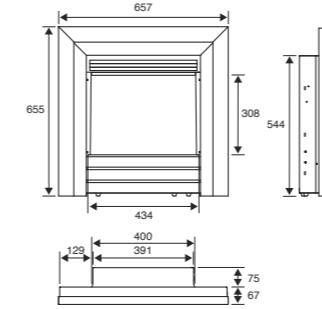

ACERO

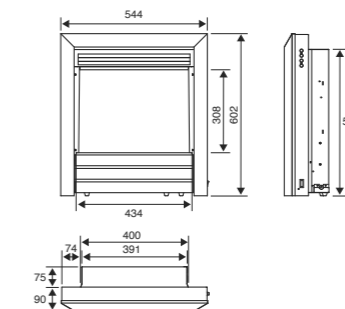

PARRILLA

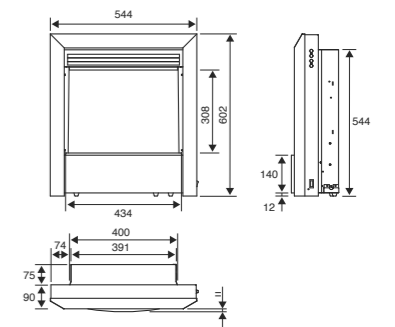

CONTEMPORARY

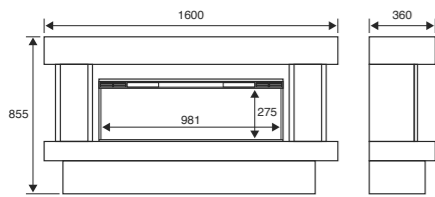

ORBITAL 1000 ILLUMIA

Wall Outset - 16-22

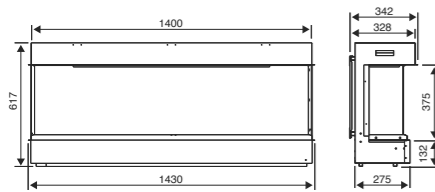

1400

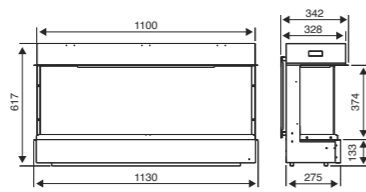

1100

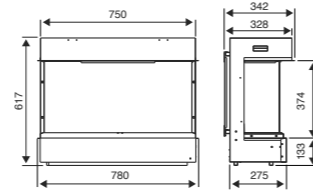

750

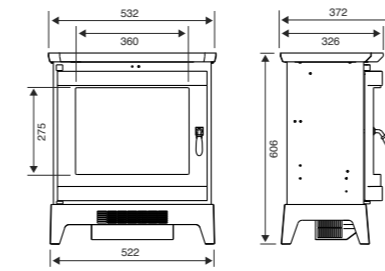

ROCHESTER

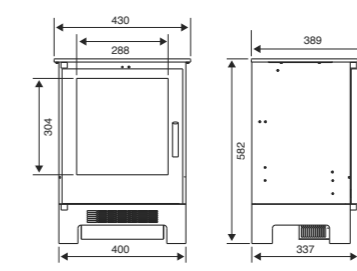

ARUNDEL

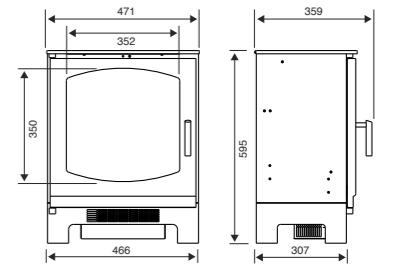

LUXIMA

ELECTRISTOVE® VR

Outset Stoves - 30-33

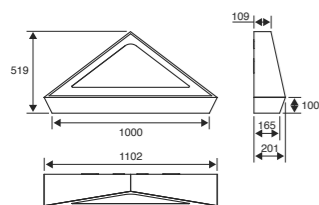

LOUVRE

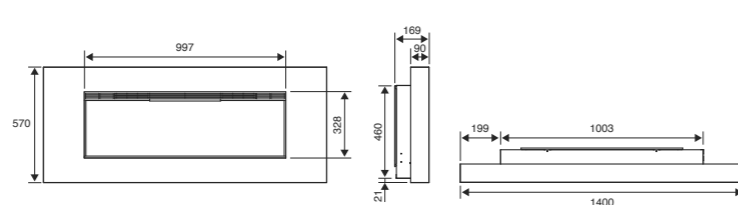

BASILICA

ULTIFLAME® VR

Outset Suites - 34-45

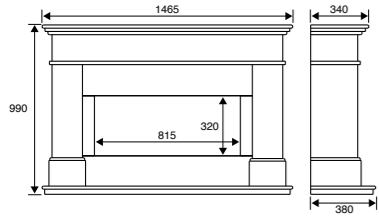

ADOUR ELITE ILLUMIA

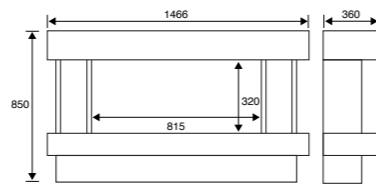

ORBITAL 800 ILLUMIA

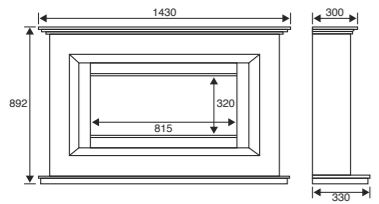

VEGA

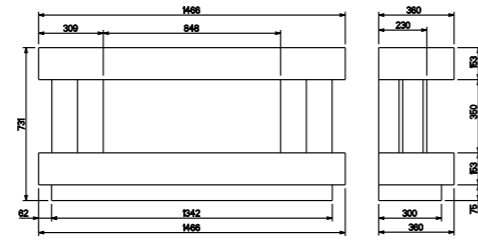

GEMMA 800 ILLUMIA

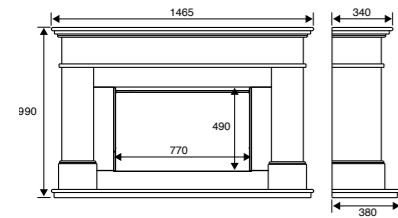

ADOUR ALEESIA ILLUMIA

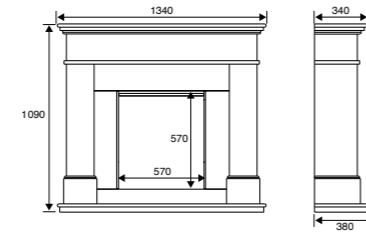

ADOUR ASENCIO ILLUMIA

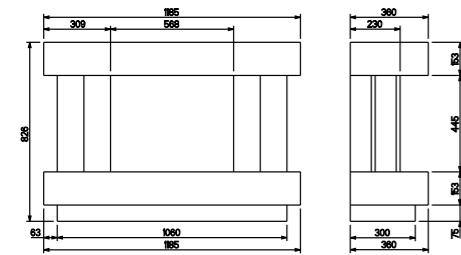

GEMMA 600 ILLUMIA

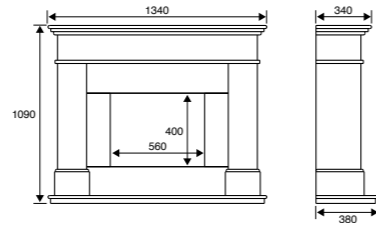

ADOUR ILLUMIA

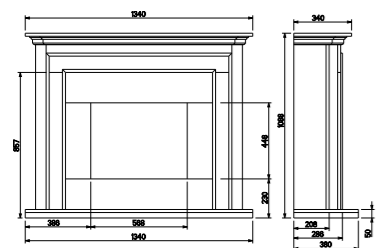

CANELO ILLUMIA

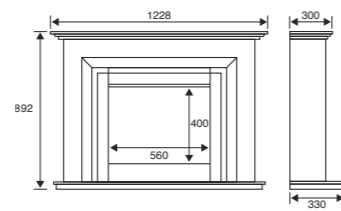

ELARA

Inset Limestone Suites - 46-52

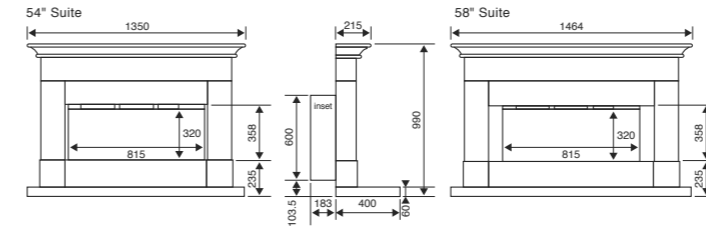

PARADA ELITE ILLUMIA

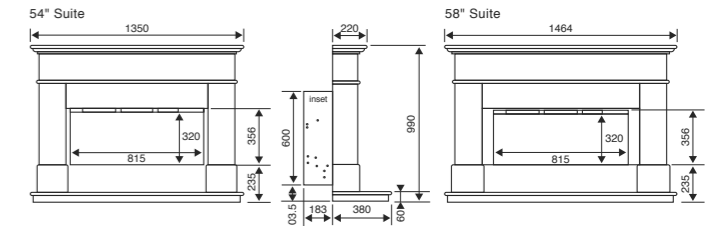

AVIGNON ELITE

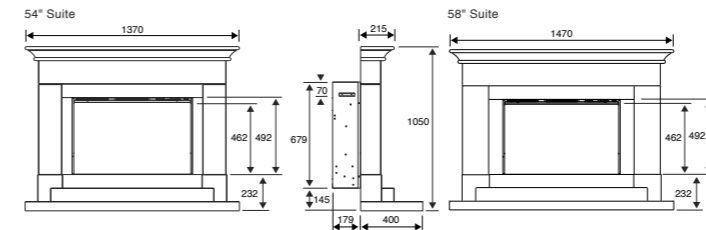

ALEESIA ILLUMIA

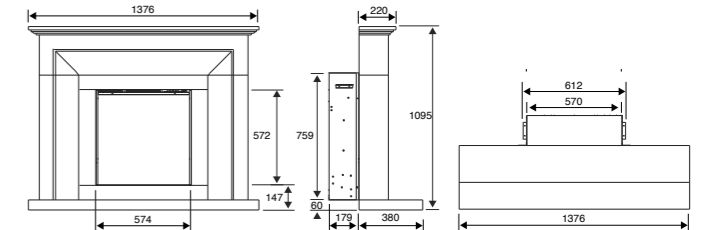

ASENCIO

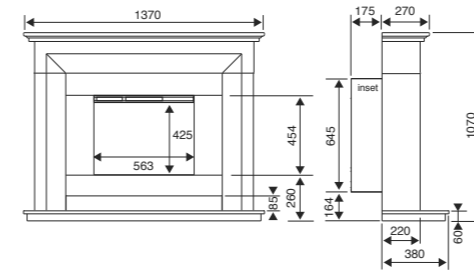

ANGELO

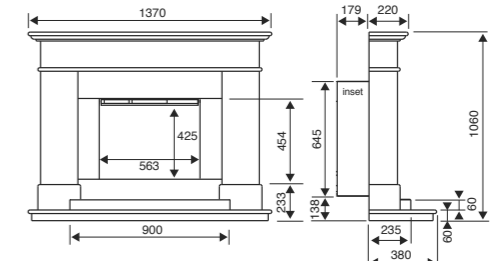

BOTICELLI

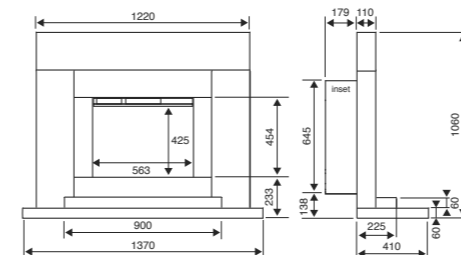

PABLO

ULTIFLAME® VR

Wall Inset - 53-61

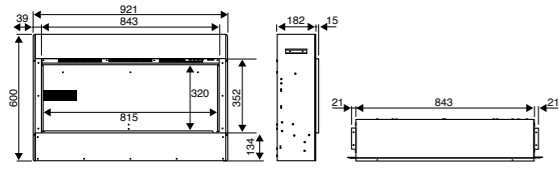

ELITE

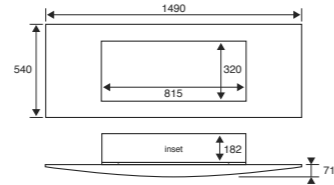

VICHY

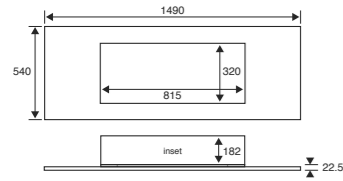

METZ

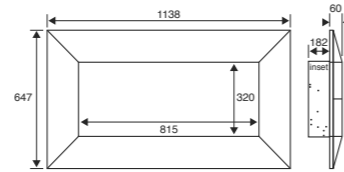

INSTINCT

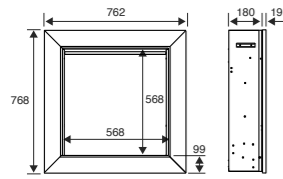

EVORA ASENCIO

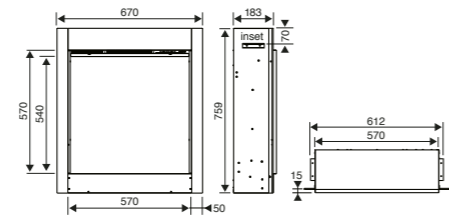

ASENCIO

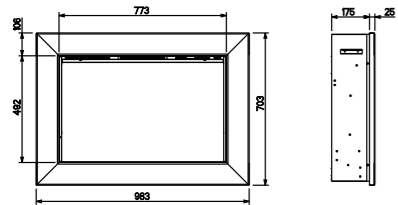

VADER ALEESIA

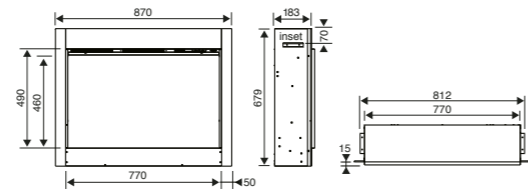

ALEESIA

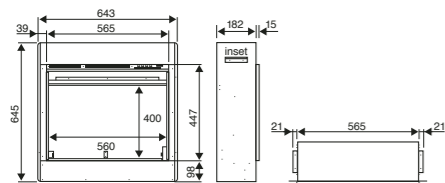

CELENA

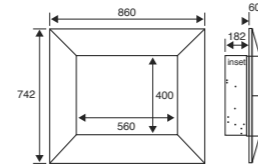

IMPULSE

Hearth Inset - 62-69

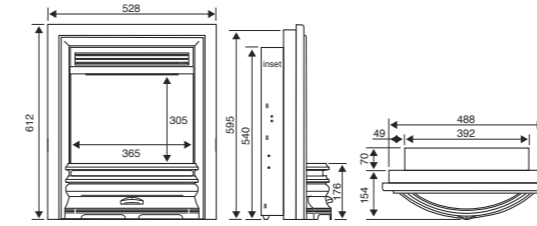

ARCADIA

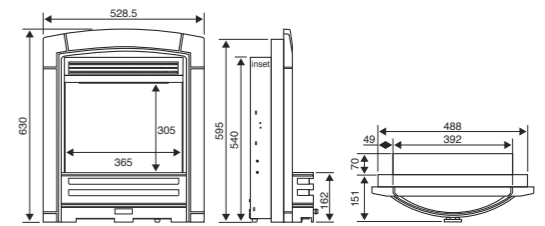

DECADENCE

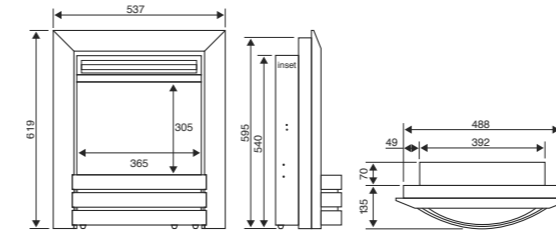

CAMBER

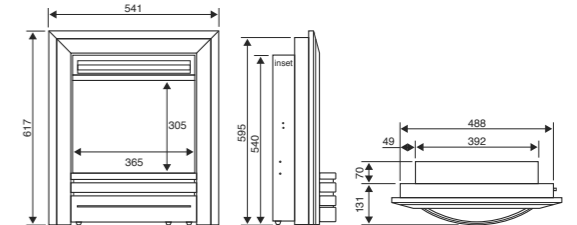

FRONTIER

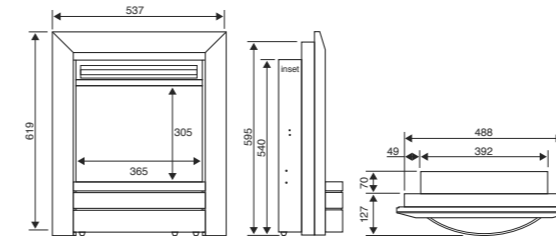

ESSENCE

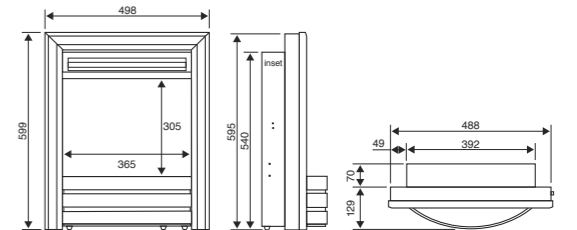

DESIGNER

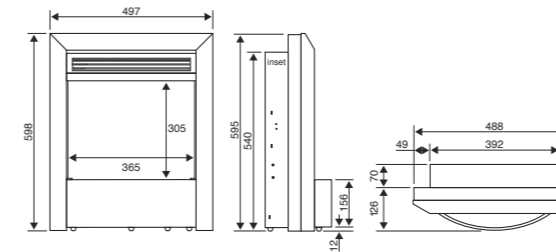

ENDURA

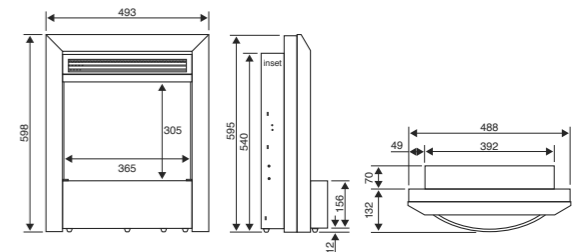

CONTEMPORARY

ELECTRIFLAME® XD

Wall Outset - 70-75

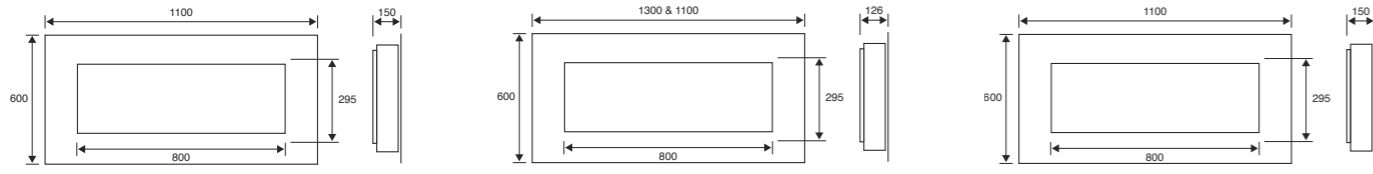

PRESTIGE

BLACK GLASS

ROYAL BOTTICINO

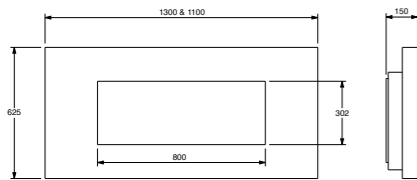

TRAVERTINE

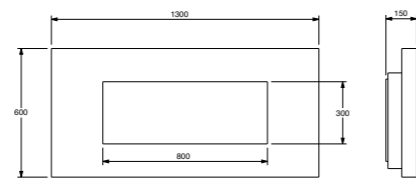

PIANO BLACK

Hearth Inset - 76-85

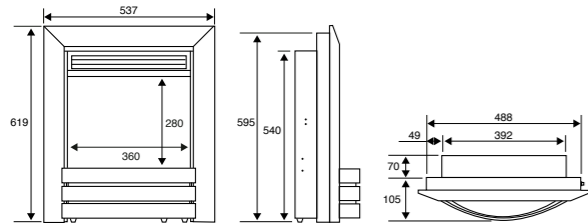

CAMBER

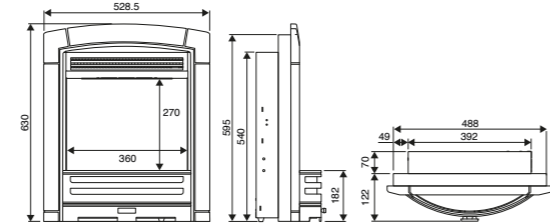

DECADENCE

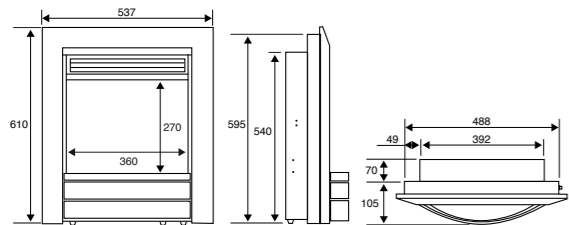

ESSENCE

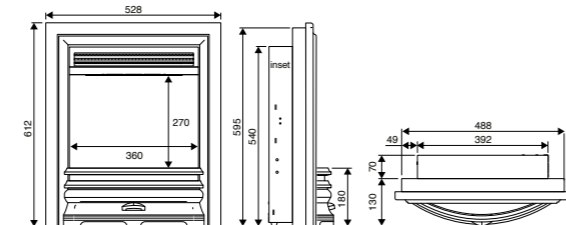

ARCADIA

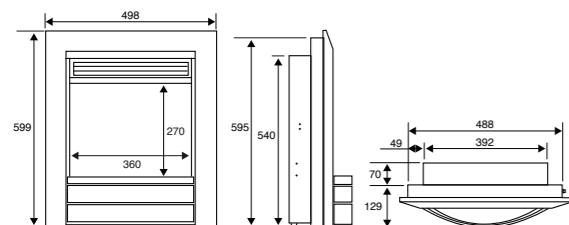

SIGNATURE

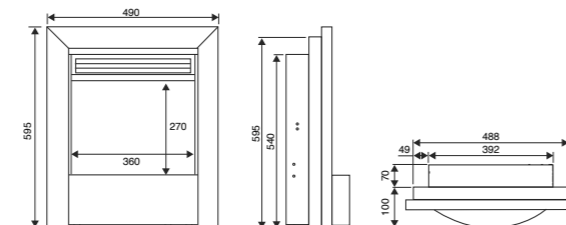

DAISY

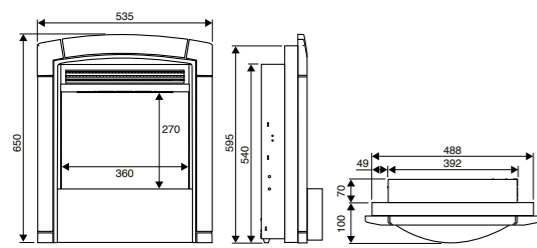

CARESS

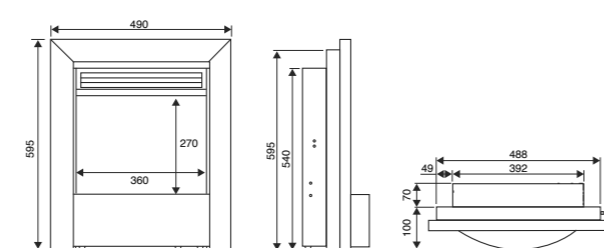

BAUHAUS

ELECTRISTOVE® XD

Outlet Stoves - 86-89

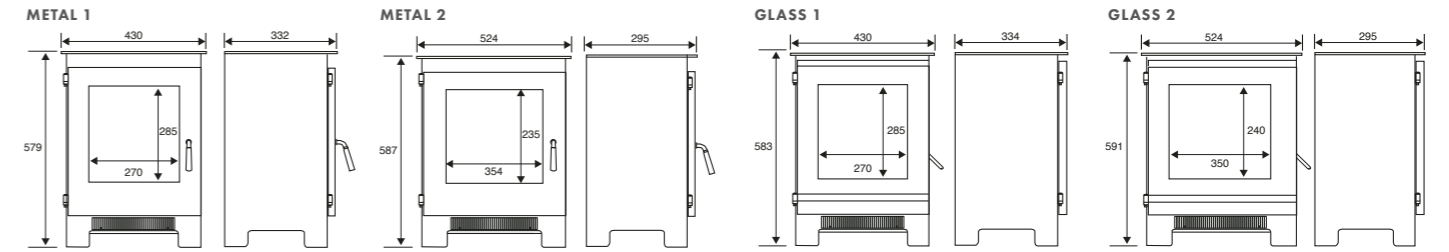

ELECTRISTOVE METAL

ELECTRISTOVE GLASS

FLAMONIK

Wall Outset - 90-91

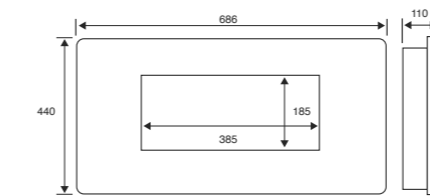

RAPTURE

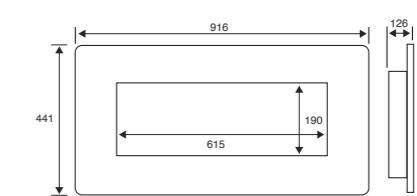

ENCHANT

ACCENT

Hearth Inset - 92-93

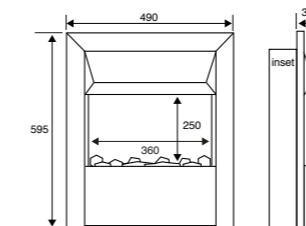

ACCENT TRADITIONAL

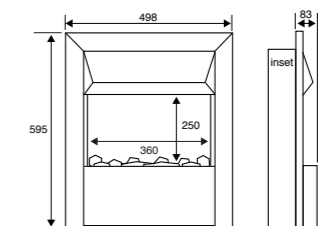

ACCENT INFUSION



DISCLAIMER

Our policy is one of constant development and improvement. We therefore reserve the right to revise designs and specifications of our products without formal notice, patents pending. We always recommend our products be viewed in an approved showroom before purchase. Whilst we have taken every care in the preparation of this brochure it is not intended to replace the installation manual which provides more detailed information.

Photography is for illustration purposes only and although every effort has been made to ensure accurate reproduction of typical installations and flame pictures they may vary according to fire model and flue types.

We accept no liability for any loss or damage arising directly or indirectly from the use of this brochure.

We recommend that all our fires are used in conjunction with central heating and not as a primary source of heat.

In the interests of personal safety a suitable fireguard is recommended when children, the elderly and the infirm are present.

This brochure is copyright 2021 and must not be reproduced in whole or in any part without prior written permission.



BFM Europe Ltd, Gordon Banks Drive,
Trentham Lakes, Stoke-on-Trent ST4 4TJ

Tel: 01782 339000

Email: sales@bfm-europe.com

www.celsielectricfires.co.uk

Go direct to the Celsi website on your smart phone or tablet device and use the app to scan the black and white QR codes shown on each page. Alternatively, go to www.celsielectricfires.co.uk to browse all Celsi electric fires.

